



GEBR. TIGGES GmbH & Co. KG
Eisengießerei und Maschinenfabrik
59302 Oelde-Sünninghausen
Telefon 02520/9355-0
Telefax 02520/9355-90

ERSATZTEILLISTE

SAATBETTKOMBINATION SBK 3006



Vor Reparaturen die Betriebsanleitung lesen und Sicherheitshinweise beachten!

SAATBETTKOMBINATION SBK 3006

Inhalt	ET-Blatt
Hauptrahmen	1
Zinkenfeld	2
Untergestänge	3
Koppelturm	4
Oberholm	5
Zylinderkonsole	6
Planierschiene	7
Nockenpacker - Reihe	8
Klemmbalken	9

Hauptrahmen - montiert
SBK 3006

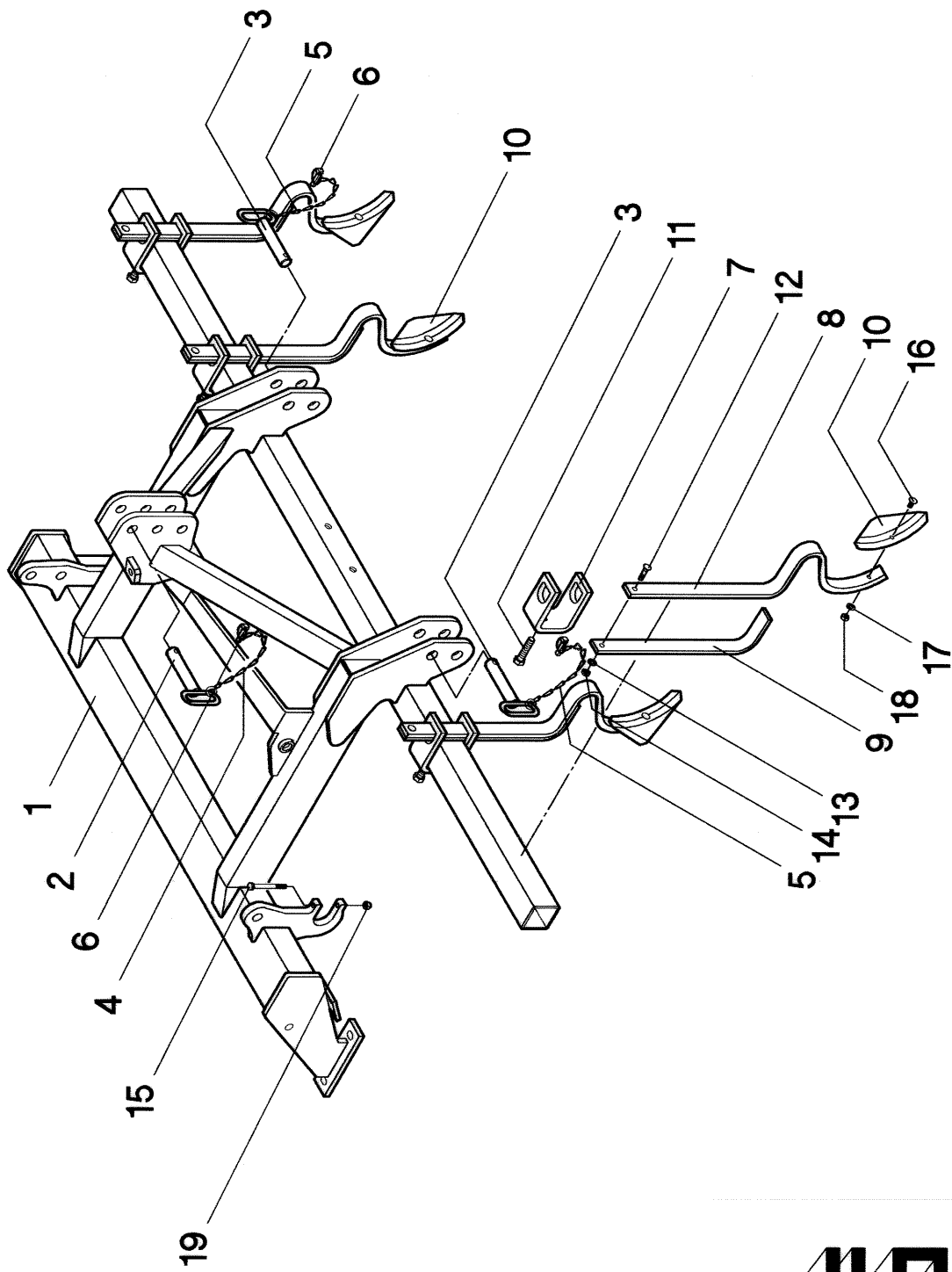



**GEBR.
TIGGES**

Hauptrahmen – montiert
SBK 3006

Pos.	Bestell-Nr.	Teilebezeichnung	Stck.
	Ref.	Designation	Qte.
	Part No.	Part Name	Qty.
1	2910 - 01402	Hauptrahmen - geschweisst	1
2	2910 - 00792	Oberlenkerbolzen - geschweisst	1
3	2910 - 00791	Unterenkerbolzen - geschweisst	2
4	2975 - 00097	Haltekette K30 8 Glieder	1
5	2975 - 00098	Haltekette K30 15 Glieder	2
6	9590 - 00033	Klappsplint Ø10,5	3
7	2950 - 03238	Spurlockererklammer FL 70x15x340	4
8	9640 - 00170	Spurlockererzinken 40x12	4
9	9640 - 00171	Verstärkungsfeder P 81/16	4
10	2910 - 01029	Einweiserschar - geschw.	4
11	9570 - 00871	Schraube M16x50/DIN 933-8.8	4
12	9570 - 00323	Schraube M12x35/DIN 603-4.6	4
13	9350 - 00041	Federring B12/DIN 127	4
14	9480 - 00095	Mutter M12/DIN 934-8	4
15	9570 - 00597	Schraube M10x100/DIN 931-8.8	2
16	9570 - 01272	Planetschraube M10x40	4
17	9550 - 00061	Scheibe 11/DIN 126	4
18	9480 - 00094	Mutter M10/DIN 934-8	4
19	9480 - 00171	Mutter M10/DIN 985-8	2
20			
21			
22			
23			
24			
25			



Gebr.TIGGES GmbH & Co.KG
Eisengiesserei und Maschinenfabrik
59302 Oelde-Sünninghausen
Tel. (02520) 9355-0
Fax (02520) 9355-90

Blatt-Nr. 1

Systeme für bessere Erträge

Zinkenfeld – montiert
SBK 3006

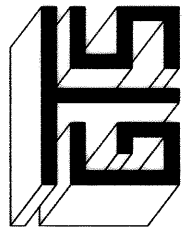
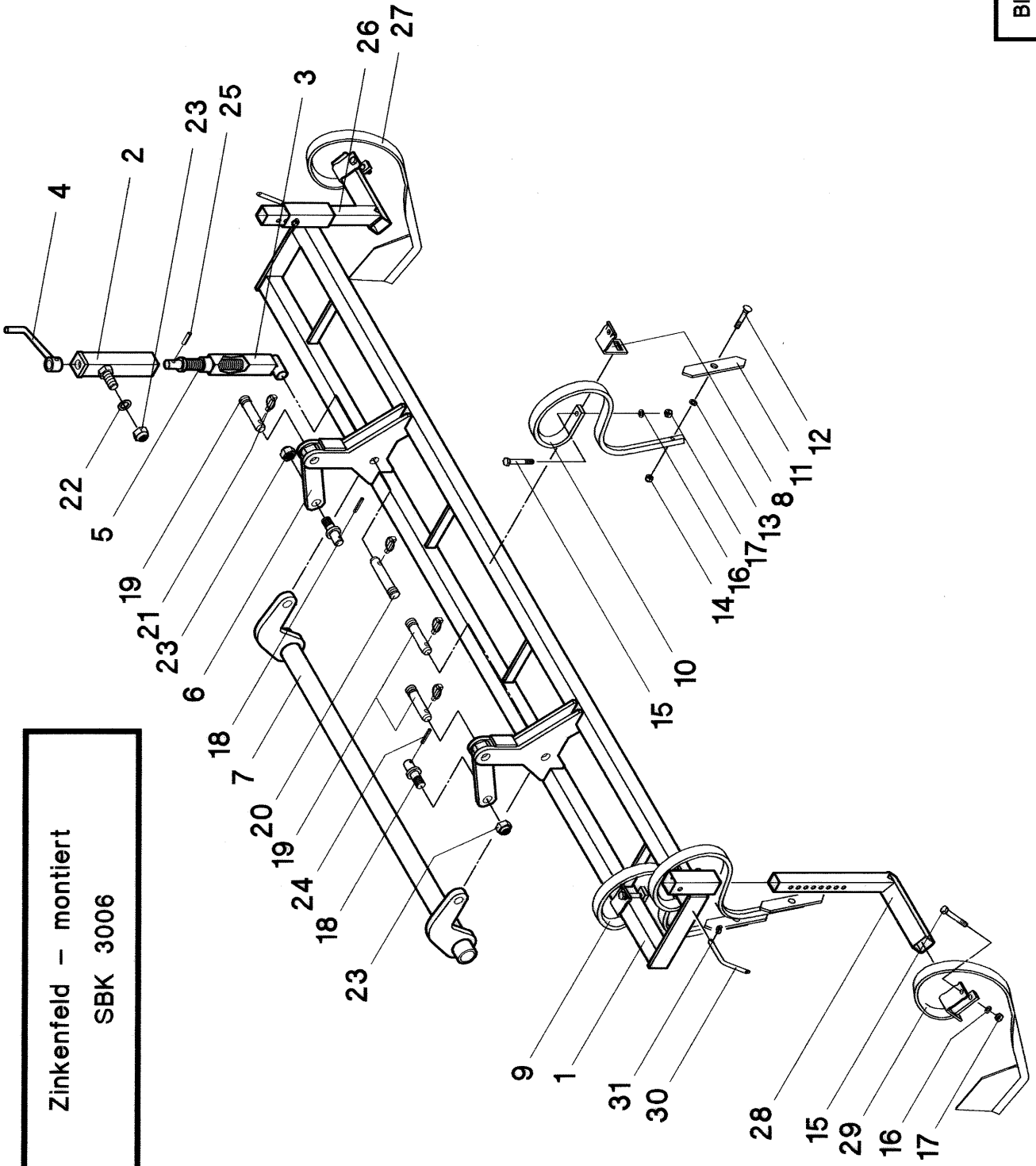



GEBR.
TIGGES

Zinkenfeld – montiert
SBK 3006

Pos.	Bestell-Nr.	Teilebezeichnung	Stck.
	Ref.	Designation	Qte.
	Part No.	Part Name	Qty.
1	2910 - 01400	Zinkenträger - geschweisst	1
2	2910 - 00354	Aussenrohr - geschweisst	1
3	2910 - 00353	Teleskopstück - geschweisst	1
4	2910 - 00355	Kurbel - geschweisst	1
5	2910 - 00356	Verstellspindel - geschweisst	1
6	2950 - 01887	Schubeisen FL 50x20x255	2
7	2910 - 01401	Hubwelle - geschweisst	1
8	9640 - 00086	Befestigungsplatte P52/11	21
9	9640 - 00080	Federzinken - komplett (Pos. 10 - 14)	19
10	9640 - 00178	Federzinken, gerade 32x12	19
11	9640 - 00078	Schar, gerade P54/6	19
12	9640 - 00148	Planetschraube M10x35	19
13	9350 - 00030	Federring A10/DIN 127	19
14	9480 - 00094	Mutter M10/DIN 985-8	19
15	9570 - 00720	Schraube M12x85/DIN 931-8.8	21
16	9350 - 00031	Federring B12/DIN 127	21
17	9480 - 00095	Mutter M12/DIN 934-8	21
18	9640 - 00206	Einschraubbolzen RD 40x90	2
19	9640 - 00001	Oberlenkerbolzen RD 25x117	3
20	9640 - 00090	Oberlenkerbolzen RD 25x153	1
21	9590 - 00033	Klappsplint Ø 10,5	6
22	9550 - 00026	Scheibe 25/DIN 125	3
23	9480 - 00127	Mutter M24/DIN 985-8	3
24	9610 - 00045	Spannhülse 8x50/DIN 1481	2
25	9610 - 00021	Spannhülse 10x40/DIN 1481	1
26	2910 - 00501	Schleppzinkenhalter, links - geschweisst	1
27	2910 - 01076	Schleppzinken, links - geschweisst	1
28	2910 - 00502	Schleppzinkenhalter, rechts - geschweisst	1
29	2910 - 01077	Schleppzinken, rechts - geschweisst	1
30	2950 - 01837	Steckdorn RD 12x155	2
31	9590 - 00031	Klappsplint Ø 4,5	2
32			

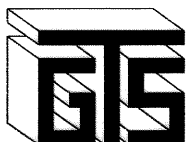

Gebr.TIGGES GmbH & Co.KG
Eisengiesserei und Maschinenfabrik
59302 Oelde-Sünninghausen
Tel. (02520) 9355
Fax (02520) 935590

Blatt-Nr. 2

Systeme für bessere Erträge

Untergestänge – montiert
SBK 3006

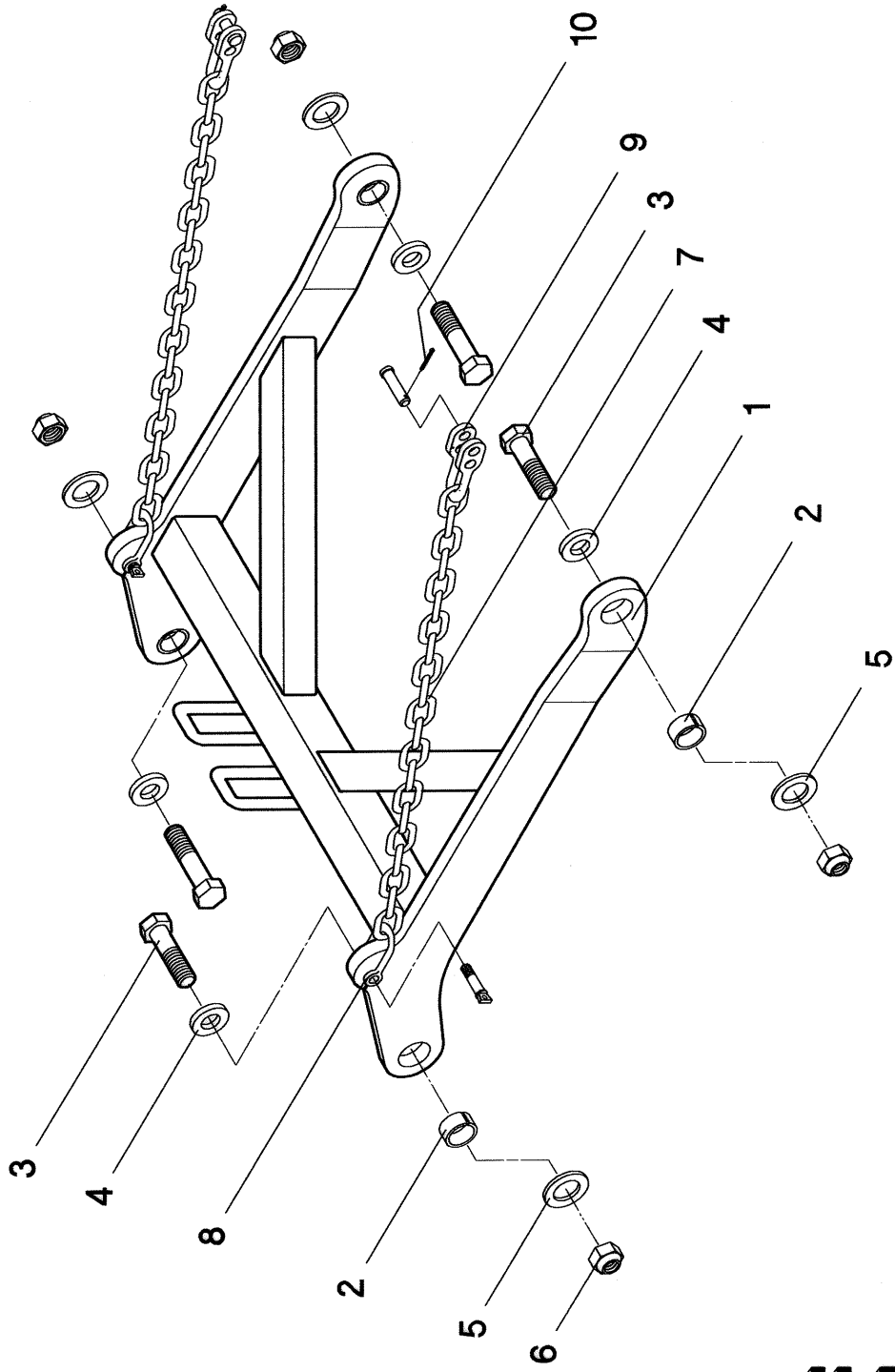

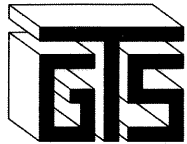

**GEBR.
TIGGES**

**Untergestänge – montiert
SBK 3006**

Pos.	Bestell-Nr.	Teilebezeichnung	Stck.
	Ref.	Designation	Qte.
	Part No.	Part Name	Qty.
1	2910 - 01394	Untergestänge - geschweisst	1
2	9640 - 00054	Einspannbuchse $\emptyset 35/43 \times 20 / \text{DIN } 1498$	4
3	9570 - 00724	Schraube $M24 \times 90 / \text{DIN } 931-8.8$	4
4	9550 - 00091	Scheibe $25 / \text{DIN } 7349$	4
5	9550 - 00067	Scheibe $36 / \text{DIN } 126$	4
6	9480 - 00127	Mutter $M24 / \text{DIN } 985-8$	4
7	2975 - 00082	Begrenzungskette $\text{Kette } 10 \times 40 \text{ } 21 \text{ Glieder}$	2
8	9640 - 00085	Schäkel $9/16'' - \text{gerade}$	2
9	9640 - 00159	Schäkel $9/16'' - \text{Nr. } 137$	2
10	9590 - 00017	Splint $3,2 \times 25 / \text{DIN } 94$	2
11			
12			
13			
14			
15			
16			
17			
18			
19			
20			
21			
22			
23			
24			
25			

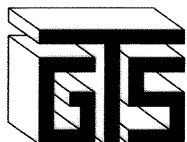

Gebr. TIGGES GmbH & Co. KG
Eisengiesserei und Maschinenfabrik
59302 Oelde-Sünninghausen
Tel. (02520) 9355-0
Fax (02520) 9355-90

Blatt-Nr. 3

Koppelturm – montiert
SBK 3006

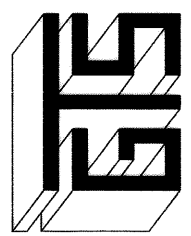
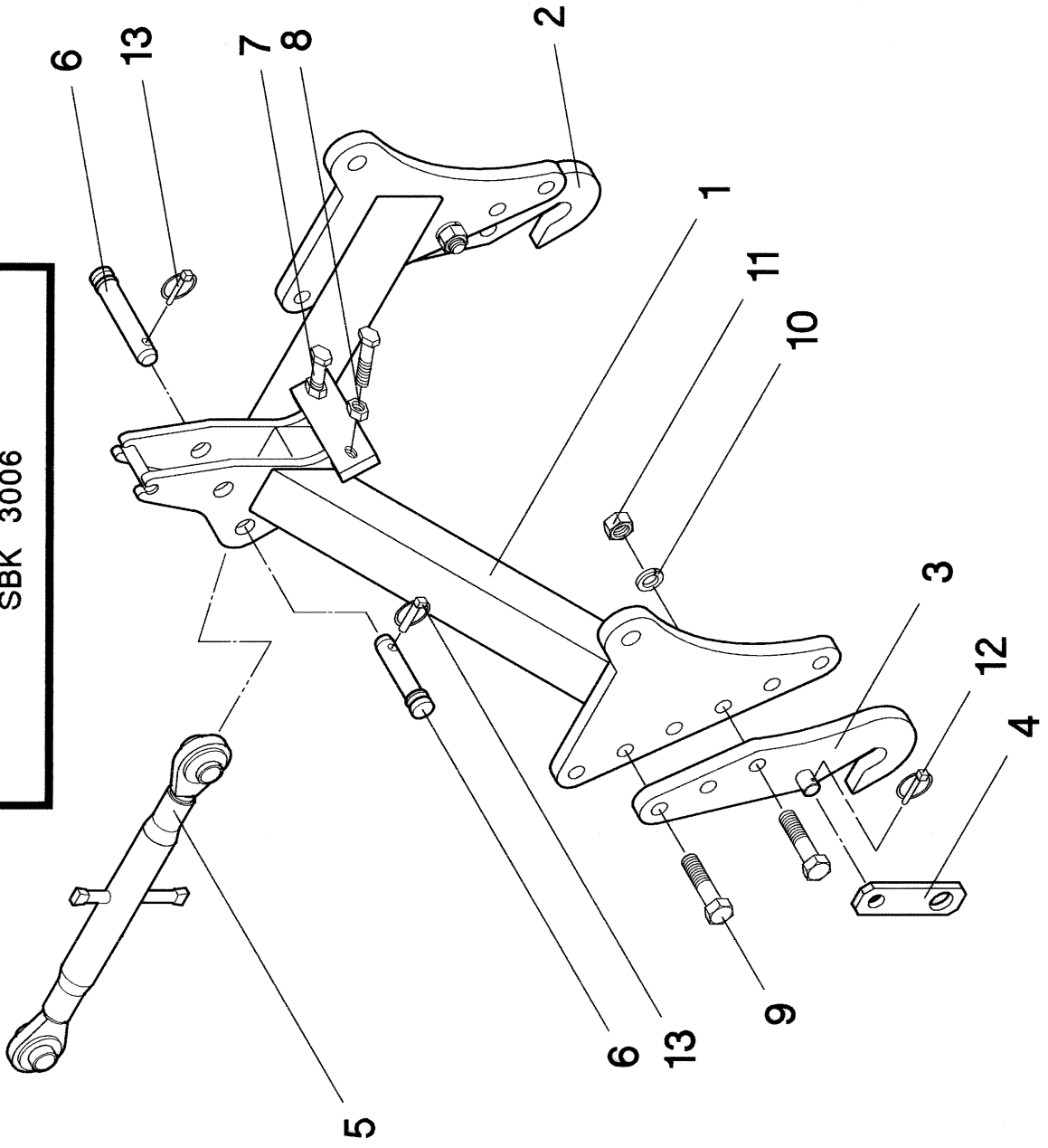

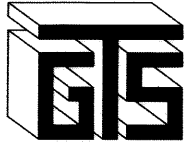

**GEBR.
TIGGES**

**Koppelturm – montiert
SBK 3006**

Pos.	Bestell-Nr.	Teilebezeichnung	Stck.
	Ref.	Designation	Qte.
	Part No.	Part Name	Qty.
1	2910 - 01392	Koppelturm - geschweisst	1
2	2910 - 01397	Kupplungshaken, links - geschweisst	1
3	2910 - 01398	Kupplungshaken, rechts - geschweisst	1
4	2950 - 00705	Verriegelungsplatte FL 45x10x150	2
5	9640 - 00088	Gewindeoberlenker Kat.II 420-620 mm	1
6	9640 - 00090	Oberlenkerbolzen RD 25x153	2
7	9570 - 00711	Schraube M16x70/DIN 931-8.8	2
8	9480 - 00097	Mutter M16/DIN 934-8	2
9	9570 - 00712	Schraube M20x70/DIN 931-8.8	4
10	9350 - 00035	Federring A20/DIN 127	4
11	9480 - 00098	Mutter M20/DIN 934-8	4
12	9590 - 00031	Klappsplint Ø 4.5	2
13	9590 - 00033	Klappsplint Ø 10.5	2
14			
15			
16			
17			
18			
19			
20			
21			
22			
23			
24			
25			

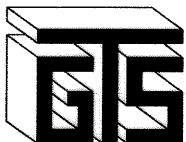

Gebr.TIGGES GmbH & Co.KG
Eisengiesserei und Maschinenfabrik
59302 Oelde-Sünninghausen
Tel. (02520) 9355-0
Fax (02520) 9355-90

Blatt-Nr. 4

Systeme für bessere Erträge

Oberholm - montiert
SBK 3006

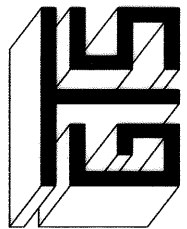
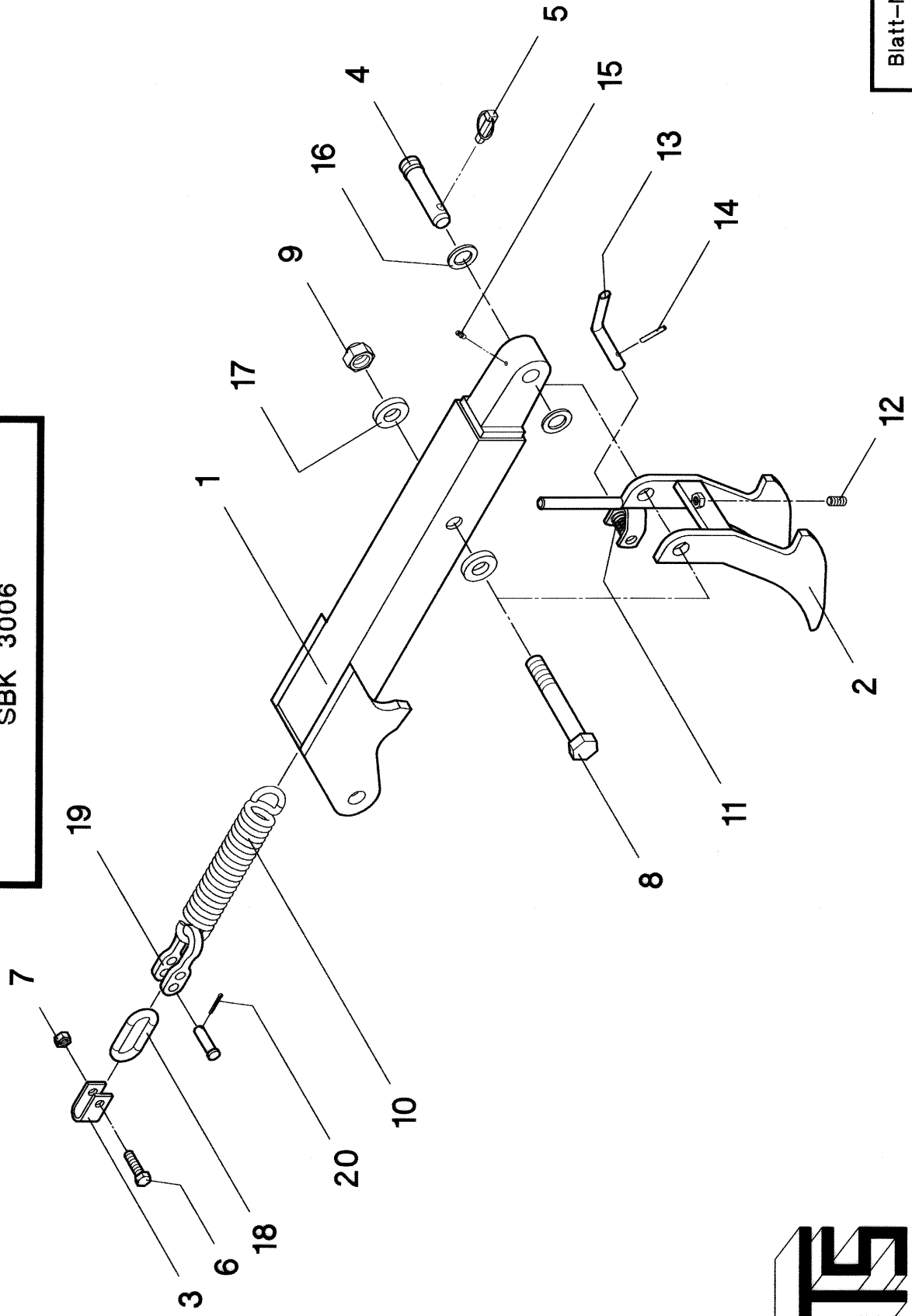

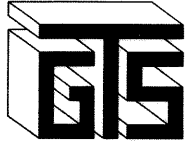

**GEBR.
TIGGES**

Oberholm – montiert

SBK 3006

Pos.	Bestell-Nr.	Teilebezeichnung	Stck.	
	Ref.	Designation	Qte.	
	Part No.	Part Name	Qty.	
1	2910 - 01393	Oberholm - geschweisst	1	
2	2910 - 01395	Verriegelung - geschweisst	1	
3	2950 - 03639	Bügelasche	FL 30x5x125	1
4	9640 - 00210	Oberlenkerbolzen	RD 25x165	1
5	9590 - 00033	Klappsplint	Ø 10,5	1
6	9570 - 00863	Schraube	M12x40/DIN 933-8.8	1
7	9480 - 00124	Mutter	M12/DIN 985-8	1
8	9570 - 00742	Schraube	M24x160/DIN 931-8.8	1
9	9480 - 00127	Mutter	M24/DIN 985-8	1
10	9640 - 00076	Zugfeder	D9,5 Da49,5 Lo315	1
11	9640 - 00053	Druckfeder	D2,5 Da21 Lo34	1
12	9570 - 00500	Gewindestift	M12x25/DIN 913	1
13	9640 - 00073	Steckbolzen	RD 16x125	1
14	9640 - 00057	Spannhülse	6x50/DIN 1481	1
15	9640 - 00020	Druckschmierknopf	H1 -Ø 6x1	1
16	9550 - 00066	Scheibe	26/DIN 126	2
17	9550 - 00091	Scheibe	25/DIN 7349	2
18	9430 - 00028	Kettenglied	Kette 13/DIN 763	1
19	9640 - 00159	Schäkel	9/16" - Nr. 137	1
20	9590 - 00005	Splint	5x40/DIN 94	1
21				
22				
23				
24				
25				

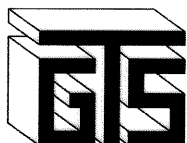

Systeme für bessere Erträge

Gebr.TIGGES GmbH & Co.KG
Eisengießerei und Maschinenfabrik
59302 Oelde-Sünninghausen
Tel. (02520) 9355-0
Fax (02520) 9355-90

Blatt-Nr. 5

Zylinderkonsole – montiert
SBK 3006

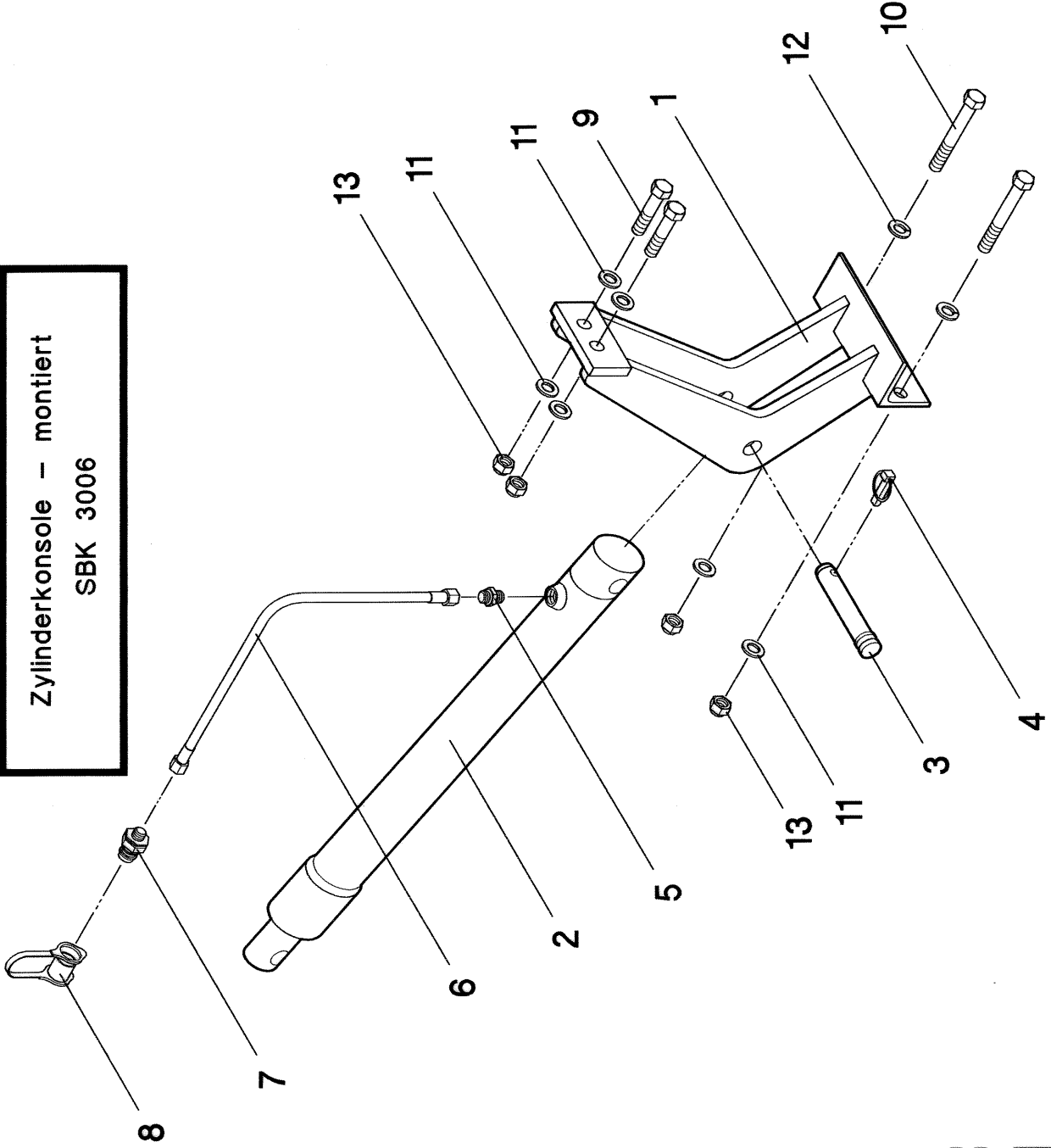

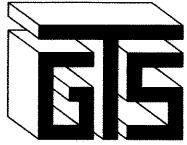

GEBR.
TIGGES

Zylinderkonsole – montiert
SBK 3006

Pos.	Bestell-Nr.	Teilebezeichnung	Stck.
	Ref.	Designation	Qte.
	Part No.	Part Name	Qty.
1	2910 - 01396	Zylinderkonsole - geschweisst	1
2	9410 - 00008	Hydraulikzylinder Ø 50x550 Hub/EL 710	1
3	9640 - 00090	Oberlenkerbolzen RD 25x153	1
4	9590 - 00033	Klappsplint Ø 10,5	1
5	9415 - 00020	Einschraubverschraubung, gerade GE 10 PL-R3/8"-250 bar	1
6	2975 - 00112	Hydraulikschlauch - komplett 1550 mm-DN 6	1
7	9415 - 00007	Kupplungsstecker, lang NG 10-10L M16x1,5	1
8	9415 - 00008	Staubschutz NG 10-rot	1
9	9570 - 00703	Schraube M16x60/DIN 931-8.8	2
10	9570 - 00728	Schraube M16x110/DIN 931-8.8	2
11	9550 - 00024	Scheibe 17/DIN 125	6
12	9350 - 00034	Federring A16/DIN 127	2
13	9480 - 00125	Mutter M16/DIN 985-8	4
14			
15			
16			
17			
18			
19			
20			
21			
22			
23			
24			
25			
26			
27			
28			
29			
30			

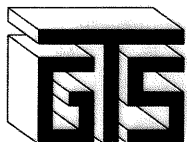

Gebr.TIGGES GmbH & Co.KG
Eisengiesserei und Maschinenfabrik
59302 Oelde-Sünninghausen
Tel. (02520) 9355-0
Fax (02520) 9355-90

Blatt-Nr. 6

Systeme für bessere Erträge

Planierschiene – montiert
SBK 3006

Blatt-Nr. 7

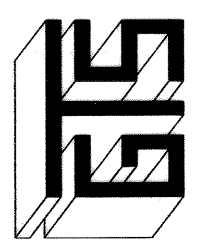
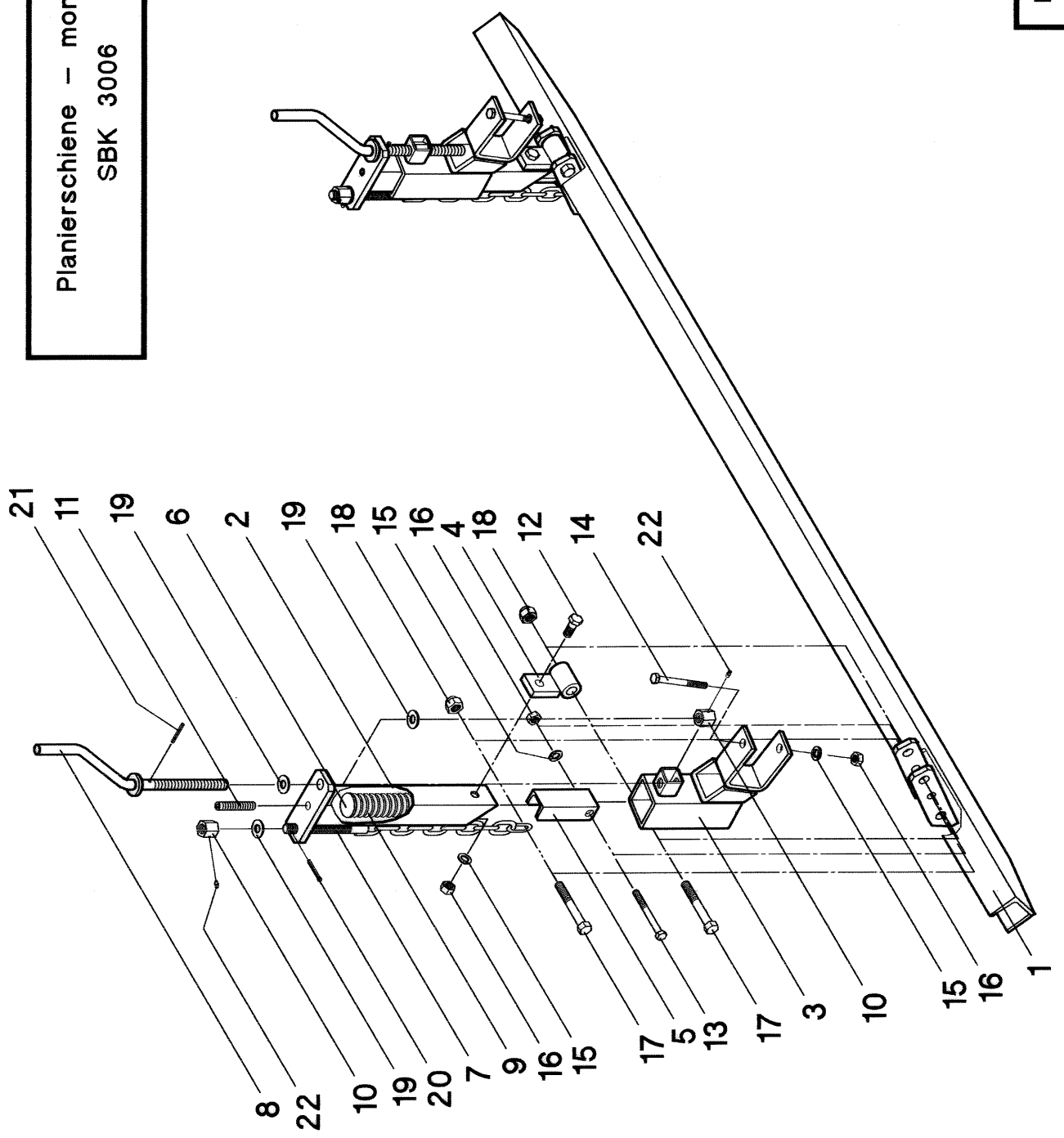

Systeme für bessere Erträge

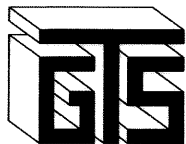

**GEBR.
TIGGES**

Planierschiene – montiert

SBK 3006

Pos.	Bestell-Nr.	Teilebezeichnung	Stck.
	Ref.	Designation	Qte.
	Part No.	Part Name	Qty.
1	2910 - 01140	Planierschiene - geschweisst	1
2	2910 - 00364	Planierschienenhalter - geschweisst	2
3	2910 - 01331	Planierschienenaufnahme - geschweisst	2
4	2910 - 00366	Gelenkstück - geschweisst	2
5	2950 - 03537	Drückhebel U 50x135/DIN 1026	2
6	2960 - 00717	Druckplatte BL 5x Ø46	2
7	2910 - 00368	Begrenzungskette - geschweisst	2
8	2910 - 01251	Kurbelspindel - geschweisst	2
9	9640 - 00139	Druckfeder d9, Da48, Lo330, n23	2
10	9640 - 00066	Trapezgewinde-Mutter TR 20x4-SW 30	4
11	9570 - 00497	Gewindestift M16x90/DIN 913-45H	2
12	9570 - 00864	Schraube M16x40/DIN 933-8.8	2
13	9570 - 00728	Schraube M16x110/DIN 931-8.8	2
14	9570 - 00731	Schraube M16x120/DIN 931-8.8	2
15	9350 - 00034	Federring A16/DIN 127	6
16	9480 - 00097	Mutter M16/DIN 934-8	6
17	9570 - 00732	Schraube M20x120/DIN 931-8.8	4
18	9480 - 00126	Mutter M20/DIN 985-8	4
19	9550 - 00025	Scheibe 21/DIN 125	6
20	9590 - 00021	Splint 5x40/DIN 94	2
21	9610 - 00039	Spannhülse 6x40/DIN 1481	2
22	9640 - 00020	Druckschmierknopf H1 - Ø6x1	4
23			
24			
25			

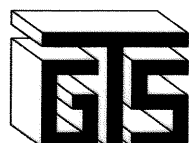

Gebr. TIGGES GmbH & Co. KG
Eisengiesserei und Maschinenfabrik
59302 Oelde-Sünninghausen
Tel. (02520) 9355-0
Fax (02520) 9355-90

Blatt-Nr. 7

Systeme für bessere Erträge

Nockenpacker-Reihe – montiert
SBK 3006

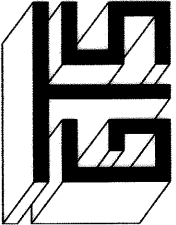
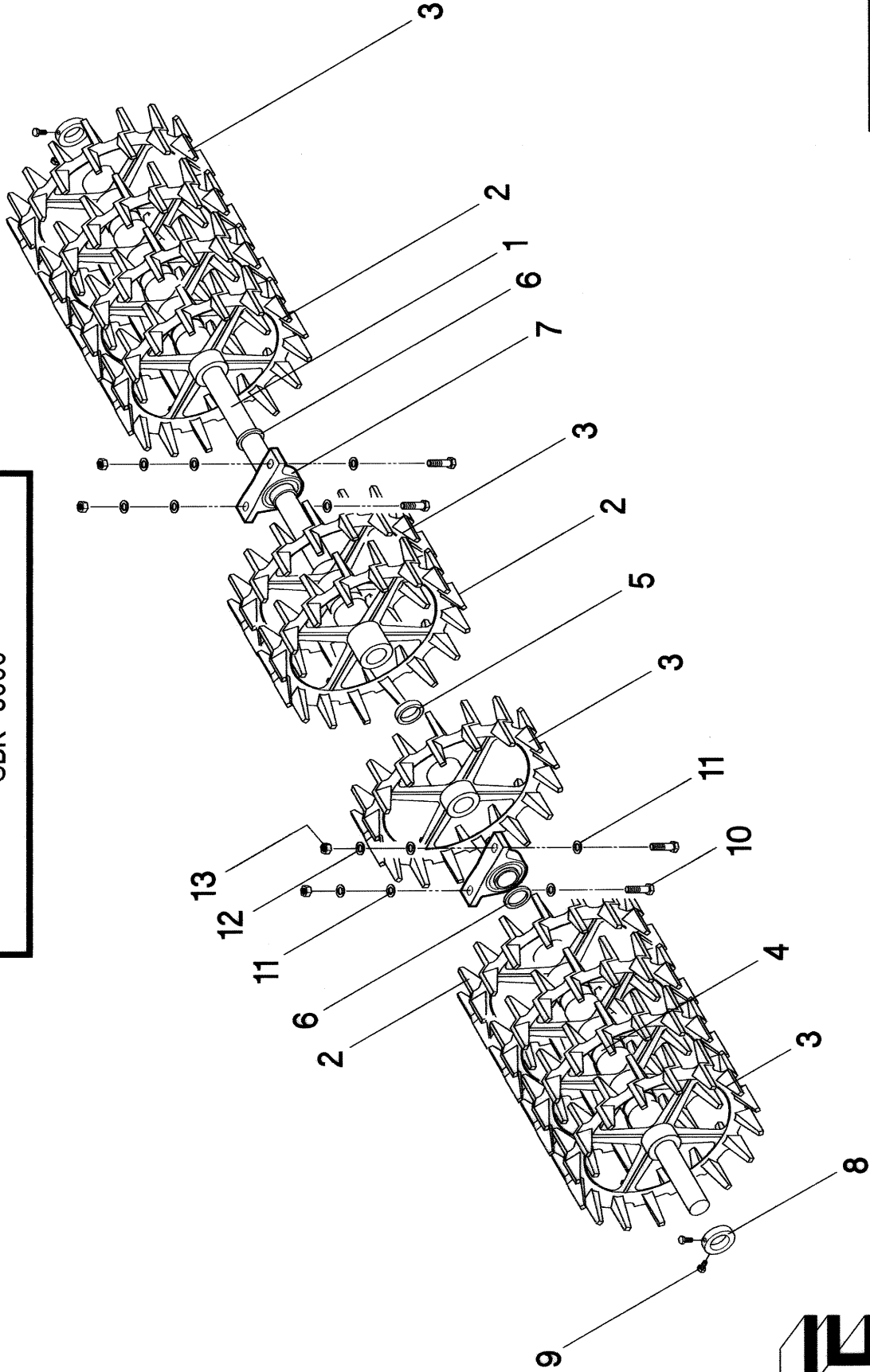

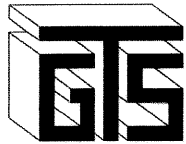

GEBR.
TIGGES

Nockenpacker-Reihe-montiert
SBK 3006

Pos.	Bestell-Nr.	Teilebezeichnung	Stck.
	Ref.	Designation	Qte.
	Part No.	Part Name	Qty.
1	2950 - 00824	Welle RD 49,9x3000	1
2	2970 - 00023	Nockenring Ø 490/51,5x154 W134	13
3	2970 - 00024	Nockenring Ø 490/51,5x139 W134A	4
4	2970 - 00197	Distanzring Ø 51/80x30 W188	6
5	2950 - 03235	Distanzring R0 76,1x12,5x14	8
6	9550 - 00084	Scheibe 51/DIN 1441	2
7	9450 - 00098	Stehlager GTS - S50	2
8	9350 - 00156	Stellring A50/DIN 705	2
9	9570 - 01316	Schraube M10x25/DIN 933-10.9	4
10	9570 - 00703	Schraube M16x60/DIN 931-8.8	4
11	9550 - 00024	Scheibe 17/DIN 125	8
12	9350 - 00042	Federring B16/DIN 127	4
13	9480 - 00097	Mutter M16/DIN 934-8	4
14			
15			
16			
17			
18			
19			
20			
21			
22			
23			
24			
25			

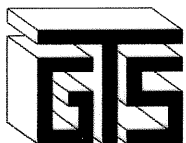

Gebr.TIGGES GmbH & Co.KG
Eisengiesserei und Maschinenfabrik
59302 Oelde-Sünninghausen
Tel. (02520) 9355-0
Fax (02520) 9355-90

Blatt-Nr. 8

Klemmbalken – montiert
SBK 3006

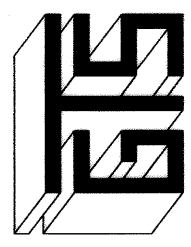
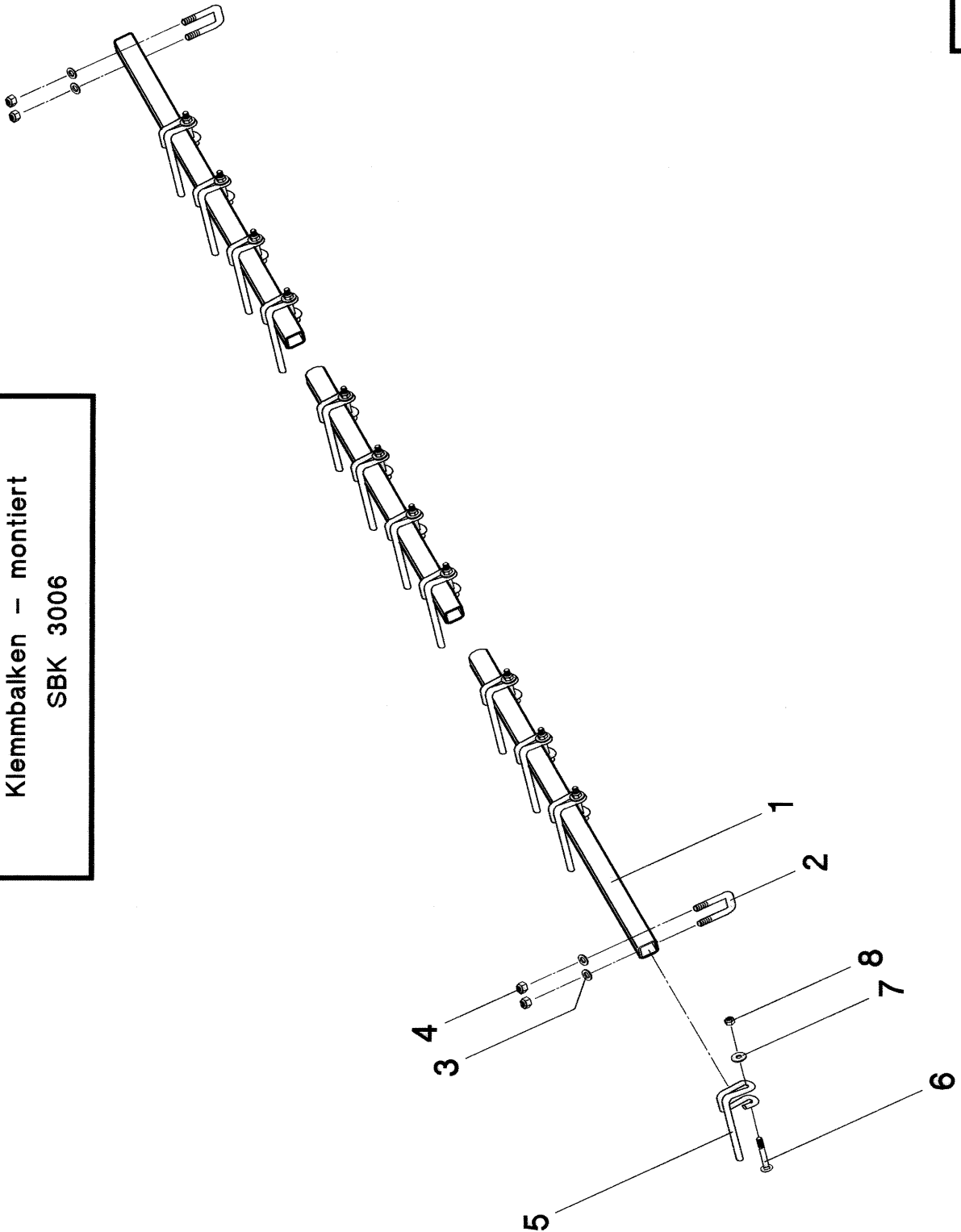

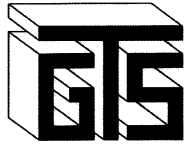

**GEBR.
TIGGES**

Klemmbalken – montiert
SBK 3006

Pos.	Bestell-Nr.	Teilebezeichnung		Stck.
	Ref.	Designation		Qte.
	Part No.	Part Name		Qty.
1	2950 - 03649	Klemmbalken	VKT-RO 40x4x2920	1
2	9640 - 00205	Bügelschraube	41x80x12	2
3	9550 - 00023	Scheibe	13/DIN 125	4
4	9480 - 00124	Mutter	M12/DIN 985-8	4
5	9640 - 00208	Abstreiferzinken	Ø 12	14
6	9570 - 01334	Schraube	M10x80/DIN 603-8.8	14
7	9550 - 00098	Scheibe	10,5/DIN 9021	14
8	9480 - 00171	Mutter	M10/DIN 985-8	14
9				
10				
11				
12				
13				
14				
15				
16				
17				
18				
19				
20				
21				
22				
23				
24				
25				
26				
27				
28				
29				
30				

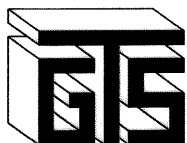

Gebr.TIGGES GmbH & Co.KG
Eisengiesserei und Maschinenfabrik
59302 Oelde-Sünninghausen
Tel. (02520) 9355-0
Fax (02520) 9355-90

Blatt-Nr. 9



GEBR: TIGGES GmbH & CO. KG

Eisengießerei und Maschinenfabrik

Oelder Straße 6 59302 Oelde-Sünninghausen

Telefon 0 25 20 / 93 55-24/21 Telefax 0 25 20 / 93 55-90

Internet: www.tigges.com e-mail: tigges@tigges.com

Systeme für bessere Erträge