



Order-No. 9198.01.51GB

Operating Instruction  
Seed Charts

***Mounted Seed Drills***  
***Multidrill eco A / eco-line A***



**Read and follow safety instructions**



## Operating Instruction

---

### **Mounted Seed Drill Multidrill eco A / eco-line A**

Before operating the rotary harrow for the first time, please read carefully through this operating manual and the safety precautions ("For your own safety") and ensure that they are observed at all times.

Ensure that the operators are properly qualified, trained in its use and everyday maintenance, and familiar with the potential hazards and accident-prevention regulations involved. Make sure that other operators are supplied with a complete copy of the safety precautions.

Ensure that all applicable accident-prevention regulations are observed, along with other generally recognized safety procedures and any legislation that may apply with respect to health and safety in the workplace.

Observe the warning labels at all times!

Instructions in this manual accompanied by this symbol and a warning label indicate DANGER. (For further details, see the section entitled "Key to pictograms".)



#### **Loss of warranty**

This rotary harrow is designed and built exclusively for standard agricultural use.

Use for any other purpose will be regarded as unauthorized operation and no liability whatsoever will be accepted for any damage or injury that may occur as a result.

The term "unauthorized operation" also covers the full observance of all operating, maintenance and servicing specifications: including, for example, the kW/PS limits and the exclusive use of original spare parts.

The use of non-original accessories, spares and/or consumables that do not carry specific approval from RABE Agrarsysteme GmbH+Co.KG shall void all warranty liabilities.

We accept no liability for damage, loss or injury resulting from the carrying out of unauthorized repairs and/or modifications to the device.

Claims resulting from missing or damaged items detected at the moment of delivery (transit damage, missing parts) should be made immediately and in writing.

Warranty claims, warranty conditions and our liability exclusions are based on our general terms of delivery.

## Table of Contents

	Page
Usage and Warranty .....	1
Brief Description of Machine .....	3
Warning Signs .....	3
Technical Data .....	4
Optional Equipment .....	4
Safety Instructions .....	5
Loading .....	6
Hitching and Uncoupling .....	6
Seed Drill Set-up .....	6
Uncoupling / Parking .....	7
Transport Preparations .....	7
Hopper: Filling/Emptying .....	8
Multiple Sowing System: Normal & Reversed Rotation ..	9
Setting Seed Rates .....	10
Gearbox setting .....	10
Slide gates .....	11
Seed Test for reversed rotation .....	11
Bottom Flaps .....	12
Fine Seed Reducer Fingers .....	12
Blank-Off Covers .....	13
Agitator Shaft .....	13
Ground Wheel .....	14
Filling Platform .....	14
Calibration .....	15
Markers .....	16
Coulter Pressure Adjustment .....	18
Hydraulic Seed Rate Adjustment .....	18
Rear Harrow Types .....	19
Coulter Change System .....	20
Drill Coulters .....	20
Press rollers .....	20
Tramlining .....	21
Pre-Emergence Markers .....	22
Hectare Meter (mechanical) .....	22
Examples of Tramlines .....	23
Operating Instructions .....	24
Maintenance .....	25
General Transport Instructions .....	27
Appendix A: Operating Instructions for Multitronic II	
Appendix B: Seed Charts	
Notes "For your own safety"	
Explanation of the pictogram symbols	

Key to illustrations: (13/1) refers to Fig. 13, item 1.

## Brief Description of Machine

“Multidrill eco-line A” are mechanical three-point mounted seed drills which are resting on the rear packer roller of the combination implement, e.g. power harrow. The impact forces allows the harrow to rise on the supporting springs, while the roller remains on the ground.

Simple coupling links are used to facilitate hitching and uncoupling; when parked, the machine sits on four removable supports.

The Multidrill can be supplied either with Suffolk, band sowing or single-disc coulters as required,

The sowing shaft drive comes from the right-hand ground wheel (optional for both sides) via a continuously adjustable two-directional oil-bath transmission, which is capable of roughly halving the speed of the sowing shaft, and when set up for the “Reversed rotation / Upper discharge system”, will also reverse the direction of rotation of the seed shaft (= sowing wheels).

On 3 and 4 m drills the left hand part of the sowing shaft can be shut-off.

A great feature of the Multidrill are the multiple sowing wheels. In the “Reversed rotation / Upper discharge system” to be used for fine seed with a rounded form, like rape seed, the accurate delivery is increased to very close to precision planting. Each individual peg carries one seed.

Steep hopper walls and the smooth feed funnels ensure consistent seed flow. Therefore the use of an agitator shaft is only required for extremely bad flowing seed stock only (grass-seed) and is not part of the standard equipment.

To facilitate handling and safe operation the design includes a water-proof hopper lid, a functionally shaped hopper with feed funnels for each sowing wheel. To adapt the Multidrill to the various types of operation, suitable equipment is available: e.g. various types of rear harrows, vertical lifted hydraulic markers, electronic tramline control incl. hectare meter and a calibration aid, low level indicator and monitoring of the sowing shaft, pre-emergence markers, hydraulic coultter pressure and hydr. seed rate adjustment and a pendulum agitator shaft for grass seed and others.

## Warning Signs (Pictograms)

Warning signs are used to indicate possible hazards; their purpose is to help ensure the safety of all those involved in operating the machine.

An explanation of these symbols is enclosed in the appendix “Explanation of Symbols”.

Please refer to Fig. 1 for their positioning (3 etc. = respective number in “Explanation” document, r = right, l = left side of machine).

Replace any missing warning signs.

If you wish to obtain these from RABE, please indicate the article number listed in the appendix.

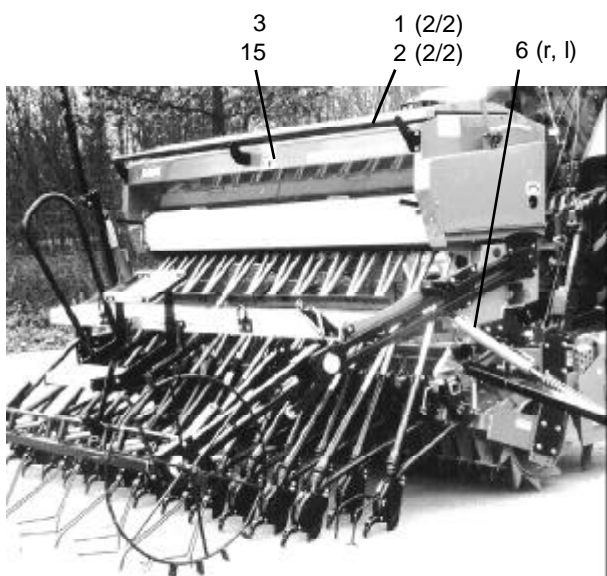

1

## Technical specifications (subject to change)

Multidrill	eco 250 A / eco-line 250 A				eco 300 A / eco-line 300 A				eco 400 A / eco-line 400 A			
W.-width cm	250				300				400			
No. of spouts	25	21			31	25			41	35		
No. of rows	25	21	19	17	31	25	21	19	41	33	29	27
Row spacing cm	10,0	11,9	13,1	14,7	9,7	12,0	14,3	15,7	9,8	12,1	13,8	14,8
Weight kg (bare)												
... Suffolk coulters	430/443	412/423	403/413	394/403	502/518	482/495	468/479	461/471	691/712	673/690	663/678	659/673
... Band sowing coulters	- / 461	- / 439	- / 427	- / 416	- / 536	- / 510	- / 491	- / 482	- / 736	- / 709	- / 695	- / 669
... Disc coulters	- / -	456/467	442/452	428/437	- / -	542/555	518/529	506/516	- / -	752/769	732/747	723/737
Hopper cap. Ltr.	410				510				720			
Transport width cm	250 *				300 *				400 *			
Filling height cm	165											
Gearbox oil	2,5 ltr. (HLP 32)											
Noise level	< "70 dB (A)"											

\* Take care of the transport width!

\*\* Transport width in excess of 3 m: see page 27.

### Standard equipment

#### Multidrill "eco-line A":

- Coulters exchange system for Suffolk coulters and band sowing coulters.  
As an option with single-disc SAX coulters,
- Hopper with low level indicator and folding lid
- Ground wheel
- Stepless adjustable two-directional oil-bath transmission
- Multi-function sowing wheels with reduction fingers (white)
- 3 m and 4 m with half side shut-off of sowing shaft (left side)
- Calibration device with crank and emptying trays
- Central and individual coulters pressure adjustment
- Removable parking stands for uncoupling/parking Light bracket (not for 4 m).

### Optional Equipment

(all weights are approximate)

- Mounting kit for power harrow / 35 kg
  - Upper discharge / reversed distribution device (e.g. for rape seed)
  - Coulters harrow / 0.6 kg/pair
  - Rear harrow, 2-piece, with drag tines / 17 kg/m
  - Rear harrow extension / 3 kg
  - PERFECT harrow with Z-tines / 22 kg/m
  - Transport tine guard for PERFECT rear harrow (2.5 and 3 m)
  - Disc markers with shear bolt and hydraulic vertical lifting / 60 kg
  - Hydraulic hose extension 0.5 m and 1.6 m
  - Electronic tramline control for 2 or 3 rows stop per track, incl. hectare meter and calibration aid
  - Low level and sowing shaft monitoring
  - Battery connection cable
  - Adapter cable for 7-pole socket
  - Extension cable 2 m, 4 m, 7 m
  - Pre-emergence markers / 35 kg
  - Hydraulic coulters pressure adjustment
  - Hydraulic seed rate adjustment
  - Agitator shaft – rotating or pendulum shaft
  - Blanking-off covers for unused spouts
  - Blanking-off covers for seed wheels in reversed rotation (black)
  - Filling platform with step and handrail / 14 kg/m
  - Mechanical hectare meter
  - Depth- limiters for Suffolk coulters
  - Press wheels for disc coulters
- Second ground wheel (left side only) for 3 & 4 m / 50 kg

## Safety Instructions



Before coupling and uncoupling, set the tractor's hydraulic unit to "Position Control"!

When coupling and uncoupling, do not allow anyone to stand between the tractor and the machine; also stay clear of the tractor and machine when the external hydraulic console is in use. Risk of injury!

Ensure that when lifted, the seed drill (with its row markers folded in) does not come into contact with other objects – e.g. with a rear-hinged window!

Ensure that there is sufficient space to manoeuvre (when the hopper is full), and attach a suitable weight to the front of the tractor.

Before operation, ensure that the tractor and machine are both in safe operating condition and that the relevant guards have been attached. The operator is responsible for safety.



Do not transport the machine with a full hopper!

Never allow anyone to climb onto or to ride on the machine (or loading platform), and keep clear of danger zones (swivel area)!

Before leaving the tractor, lower the machine, switch off the engine and remove the ignition key.

Always lower the machine prior to performing adjustments or repairs.

Do not reach into the hopper or place objects into it when empty. The agitator (if installed) may turn if the machine is pushed (when the spur wheel is turned) with transmission in > "0" position. Danger of injury or damage to machine!

When filling the hopper with treated seed and cleaning with compressed air, please note that seed dressing is toxic and irritant. Wear appropriate protective clothing!



Ensure that no one is near the machine before operating or towing.

On steep slopes, allowances are to be made for the centre of gravity of the purchased combination.

Before using the machine for the first time – and after long downtimes – check the oil level in the transmission and that all bearings are adequately greased. Check that all screws are tightened, and that there is no leakage in the hydraulic unit.

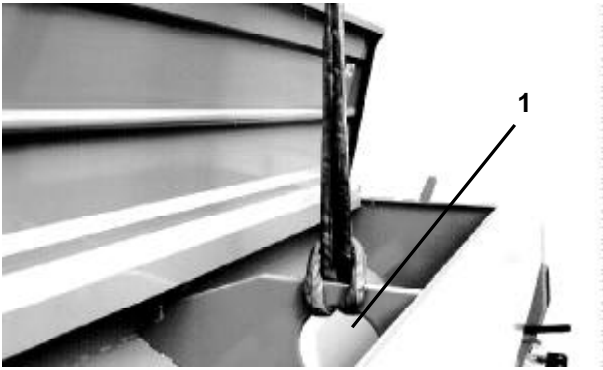

2

### Loading

Hook in **with textile belts only** in the middle wall opening (2/1) and the 2 eyes (4/1) – for “4 m” 2 x middle wall opening.

Lift only by itself and with empty hopper (without soil-working machine).

Ensure sufficient load bearing capacity of belts.

Handle carefully, keep balanced.

Keep clear of suspended loads.

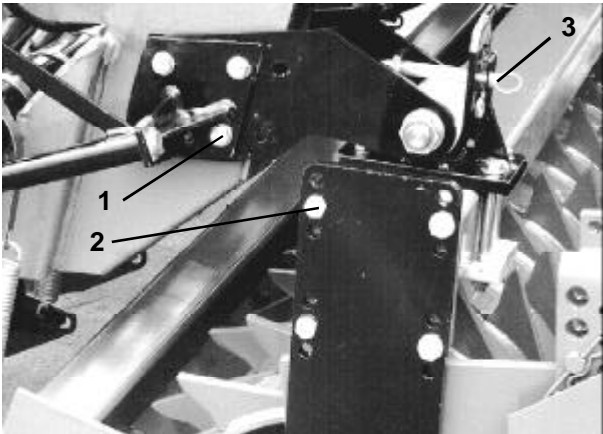

3

### Set-up

The structure of the tiller or rotary harrow must be suitable to carry the seed drill.

For the 2,5 m and 3,0 m RABE MKE power harrow are extra reinforcement struts from the headstock to the trough required.

Perform set-up on level ground and with empty hopper only. Ensure that the unit is safely parked for mounting and parked on firm and level ground.

Fit the mounting brackets on both sides (3/1+2) in such a way that that the seed drill rests close to the packer roller and the distance between the lower edge/coulter rail and the ground is **approx. 44 cm for operation.** (5/1)

Drive under the empty, supported “Multidrill A” with the tiller / power harrow and couple; secure with pins (3/3).

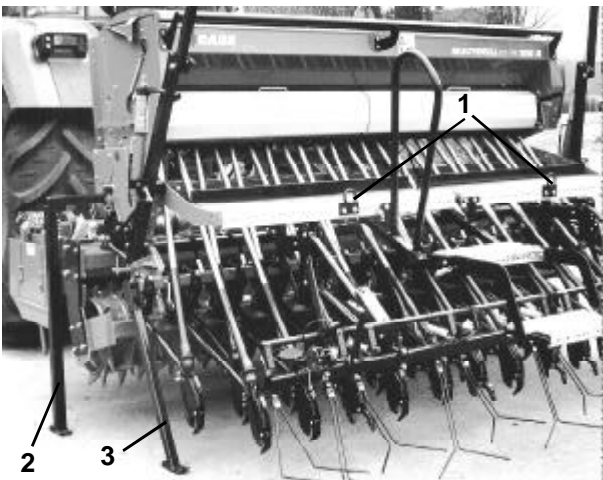

4

Lift the machine and remove front supports (4/2) then lower and connect top link (5/2).

Lift the machine again and remove back supports (4/3).

(The supports may remain attached to the seed drill; insert the front supports, pointing upwards, into the holders, then insert the back supports (5/3.)



5

Adjust the top link so that the tiller / power harrow and the seed drill are horizontal during operation (viewing from the side).



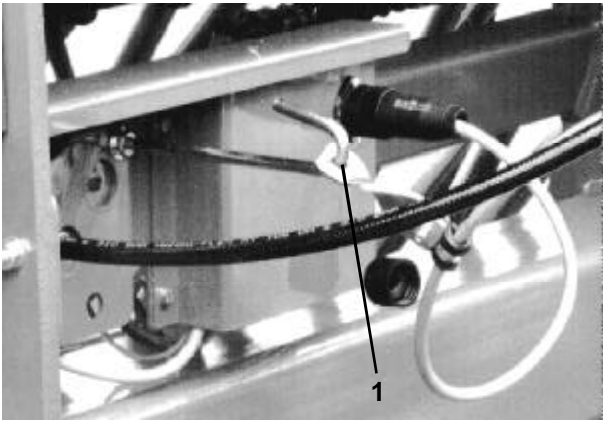

6

Connect the hydraulic hose for the markers to a single-acting spool valve.  
 The power supply for electronic tramlining control is 12 V from a 3-pole constant current socket (DIN 9680).  
 If this is not available, a battery connection cable with socket or an adapter for the 7-pole trailer socket (requires parking light in operation to be switched on) can be supplied by RABE as optional equipment.  
 Place the cable in the hooks on the seed drill side to take strain off plug connection – see (6/1).

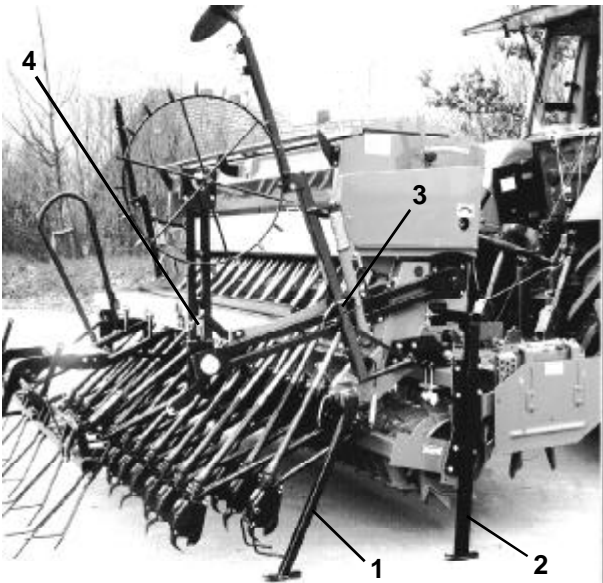

7

### Uncoupling / Parking

Use reverse procedure. First attach back supports, uncouple top link, then attach front supports.  
 Secure parking supports (7/1+2) with pin. Ensure that the surface is firm and level!  
 The hopper must be emptied beforehand.

### Transport Preparations

Transport with empty hopper only.  
 Close the hopper lid.  
 Fold up the emptying trays ensuring they lock in.  
 Fold up the collapsible tread-step.  
 After folding in the markers secure with pin (7/3).  
 Fold up and lock the ground wheel in place (7/4).  
 Fold up the tramline markers and secure with pin (10/1).  
 Fold up the parking supports (7/2)

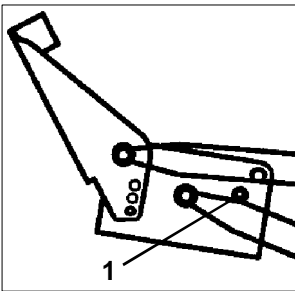

8

Attach the tine guard (optional equipment) to the PERFECT rear harrow 2.5 and 3 m (56/3).  
 Lift the rear harrow up and use the pins to secure it in the drill holes (8/1). Also for transport on a low-loader.



10

When transporting the machine on public roads, mark the outline with warning signs and connect lights.

**See Transport Instructions page 27!**

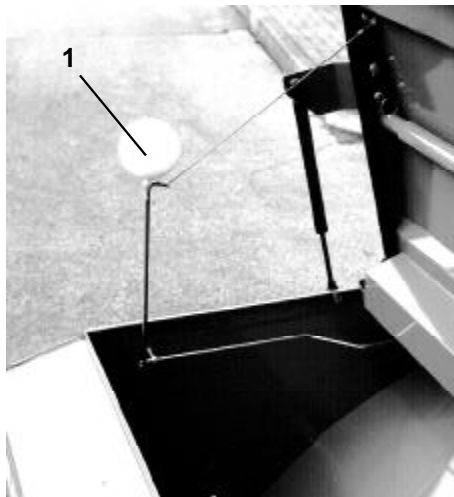

11

### Hopper: Filling/Emptying

The seed drill should only be filled after it has been mounted and lowered.

The seed level is shown on the indicator (front hopper wall).

Observe the swimmer when filling the seed drill (**11/1**).

Do not run the hopper empty. When seed level is low, ensure even distribution.

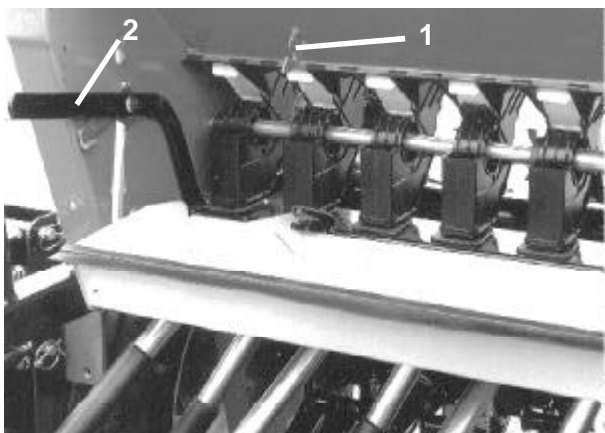

12

### Emptying

Lower the drill.

Lift the emptying trays so that they unlock (at **12/1**), and place horizontally.

Unlock the seed pipe rail on both sides with the lever (**12/2**) and lower.

Place the trays on the seed pipe guide rail (**13/1**).

Open all shutters (**13/2**).

Open the bottom flaps as far as possible. Move the lever to full extent (**14/1**).

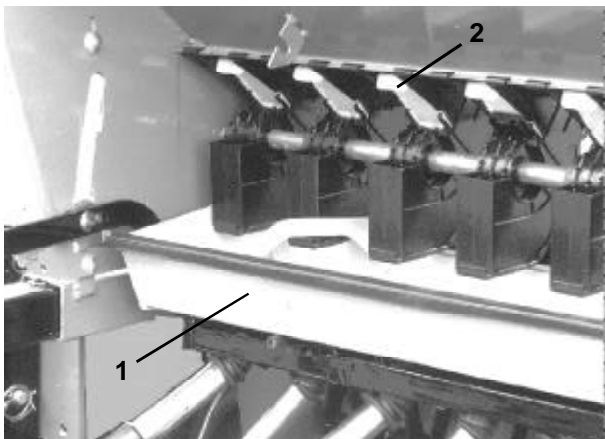

13

**Cleaning the Hopper:** Blow out residue with compressed air. Wear protective clothing against toxic seed dressing dust.

Leave the gates wide open so mice, for example, do not smell the seed and attempt to chew the plastic parts on the parked drill.

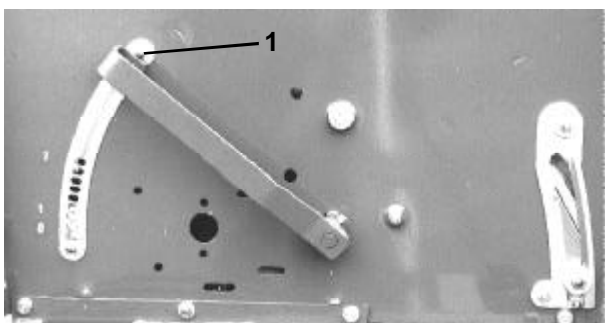

14

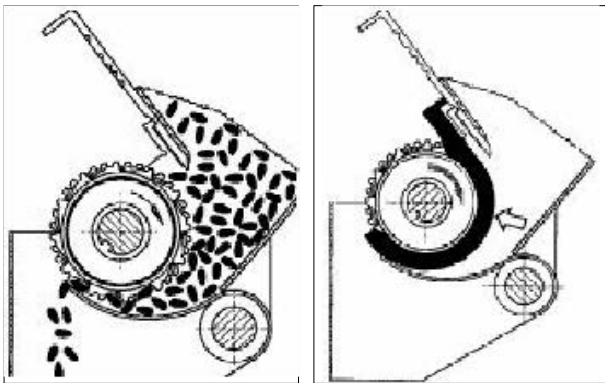

15

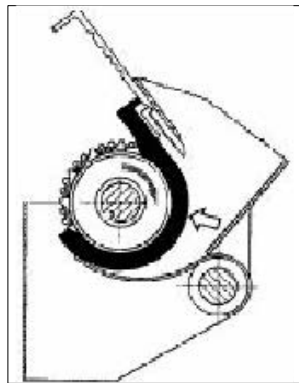

16

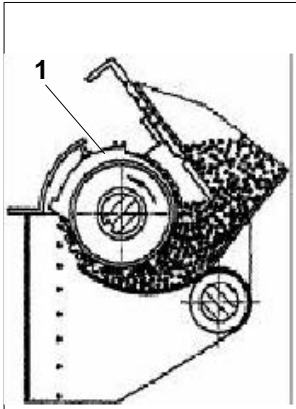

17

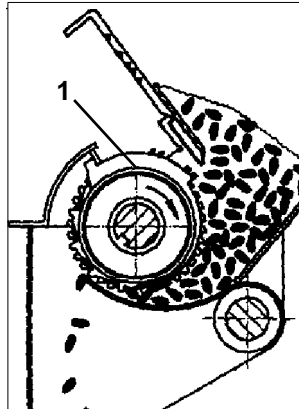

18

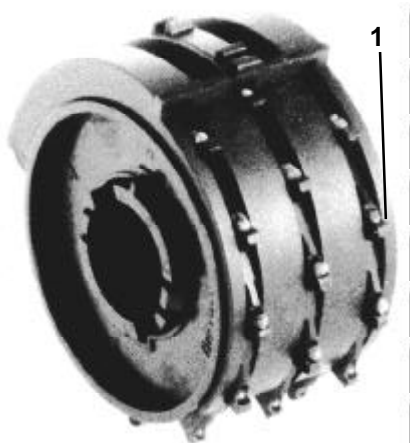

19

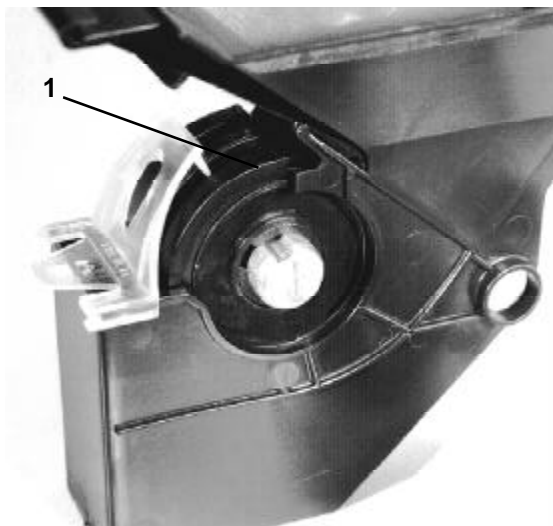

20

## Multiple Sowing System

In order to provide the best possible performance for each size of drillable seed type, seed rate and spacing requirements, the Multidrill offers four types of discharge systems:

1. **Normal rotation of seed wheels / Bottom discharge position**
  - for coarse seed such as grain, beans, peas etc. (Fig. 15). Without reduction fingers or blank-off covers
2. **Normal rotation of seed wheels / Bottom discharge position**
  - for low seed rates of rape (3,0 kg/ha plus), phacelia (10 kg ha plus), mustard (max. seed size: 3.3 mm) (Fig. 16)
  - with additional reduction fingers (white at a earlier stage yellow) standard supply
3. **Normal rotation of seed wheels / Bottom discharge position**
  - for reduced sowing rate of Hybrid grain below 100 kg/ha (Fig.18)
  - with additional blank-off covers (black) fitted in rear position (Fig.18/1). Optional equipment.
4. **Reversed rotation / Upper discharge position**
  - for fine seed such as vegetable seed, oil seed rape (min. apprx 1 kg/ha) (Fig. 17)
  - Precision planting for individual seed sowing with blank-off covers (black) in mid-position 17/1). Optional equipment.

The reversed rotation variation also offer the option of **halving the sowing shaft speed** by using a reduction of the gears.

### The Advantages of reversed rotation / Upper discharge position (Optional equipment)

By reversing the direction of rotation of the seed shaft, each sowing wheel peg with its specially shaped cups (19/1) picks up a seed kernel, transports it through the blank-off cover (20/1), and then releases it into the seed pipes to the drill coulters.

The precision planting of individual seed kernels enhances seed distribution and plant development and leads to greater yields while also saving on seed stock.

The Multidrill reversed rotation position is only suited for round and regular seed of approx.

**1.8 - 2.8 mm Ø** especially for oil seed rape and kale-like seed.

- the seed must be free of any loose dressing rub-off and its surface may not be sticky. Brush off any seed dressing residue in the cups.

Seed containing additives such as additional dressing and slug pellets is **not** suitable for drilling in reversed rotation position .

- to achieve even seed distribution, we recommend to never drive faster than **6 km/hr**.

Strong vibrations, caused by stones and large clods of earth for example, will affect the quality of distribution.

- the angle of inclination should not exceed **15%**.

For conditions other than those described above, we recommend to use the "reversed rotation position" with blank-off covers (black).

This also applies for hybrid rape varieties with irregular seed sizes.

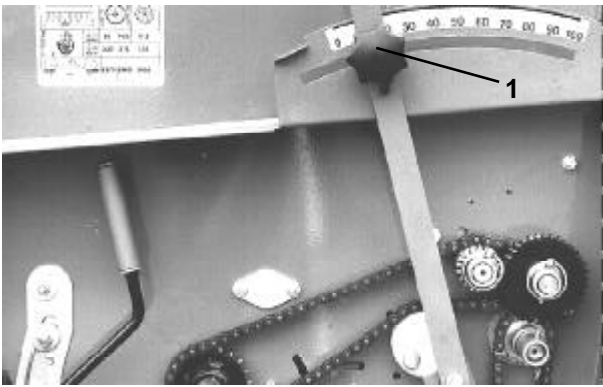

21

### Setting Seed Rates

Use the seed rate chart to determine the seed rate and make appropriate settings.

The sowing shaft direction changing kit and the black blank-off covers incl. plastic cover clamps is part of the "Reversed rotation kit/Upper discharge device" available as optional equipment.

Necessary adjustments:

- Gearbox setting (direction of rotation of the seed shaft/ seed wheels)
- Slide gates
- Bottom flap
- Reduction fingers
- Blank-off covers
- Agitator shaft

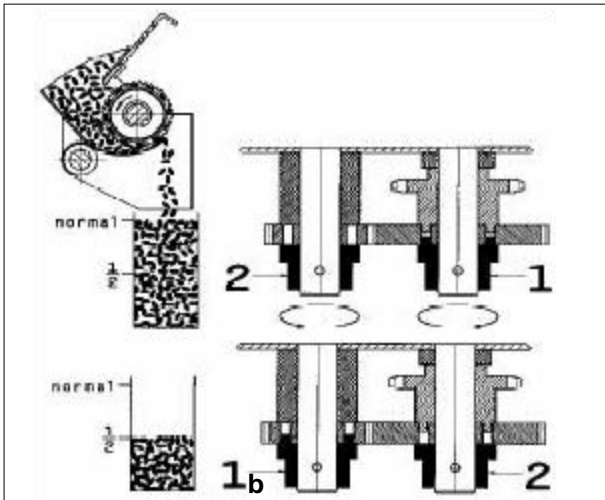

22

### a) Gearbox setting

The oil-bath transmission is continuously adjustable from 0 to 100 (0 = sowing shaft at standstill).

Indicated value = forward lever side (towards 100). Secure lever using star handle (21/1).

Using the reduction the sowing shaft speed may be halved in "Normal rotation position/bottom discharge".

If a very low seed rate requires a gear setting of **below 10**, you can use the reduction to halve the sowing shaft speed and double the transmission set value (then re-calibrate).

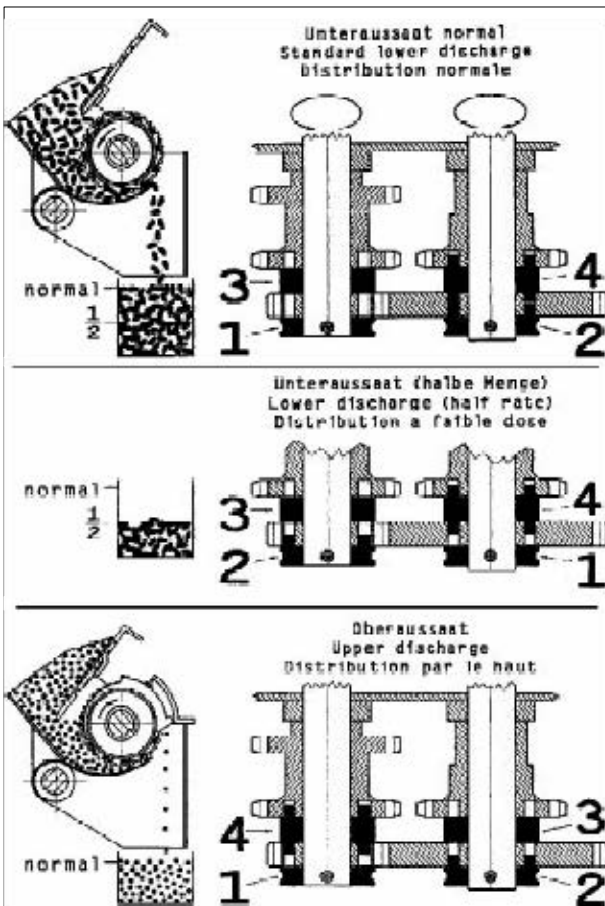

23

### Halve revs of sowing shaft

Can be adjusted on the right-hand side of the drill – open the transmission cover – by changing the setting of the carrier (22/1 or 23/2) and the spacer disc (22/2 or 23/1).

Standard rpm – carrier to the right (22/1a, 23/2a)

To ½ the rpm – carrier to the left (22/1b, 23/2b)

### Changing the Direction of Rotation of the Seed Shaft

Mount the carrier (pl.) (23/2+4) and spacer discs (23/1+3) as stated:

Normal rotation: } Carrier to the right (2 black./4 blue)  
 (Normal rpm) } Spacer discs to the left (1 red/3 green)

Normal rotation: } Carrier (2 black) to the left  
 (½ the rpm) } Spacer disc (1 red) to the right

Reversed rotation: Carrier (2 black) to the right  
 Carrier (4 blue) to the left  
 Spacer disc (1 red) to the left  
 Spacer disc (3 green) to the right



Close the transmission cover after making the settings and keep closed during operation!

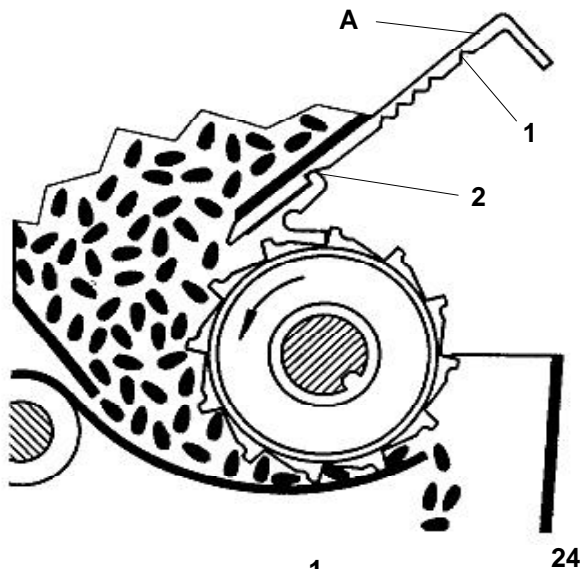

24

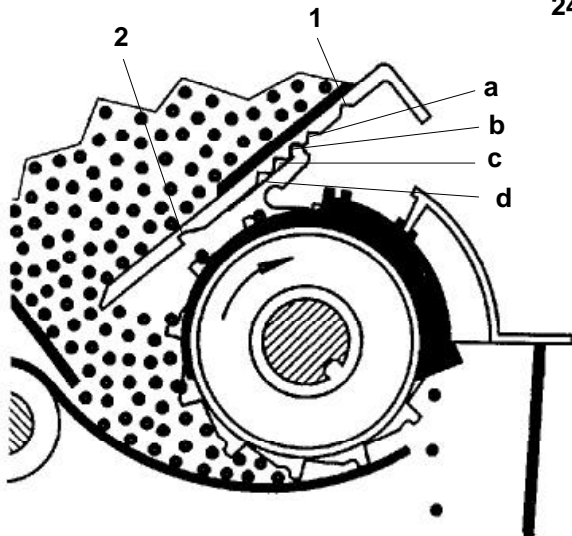

25

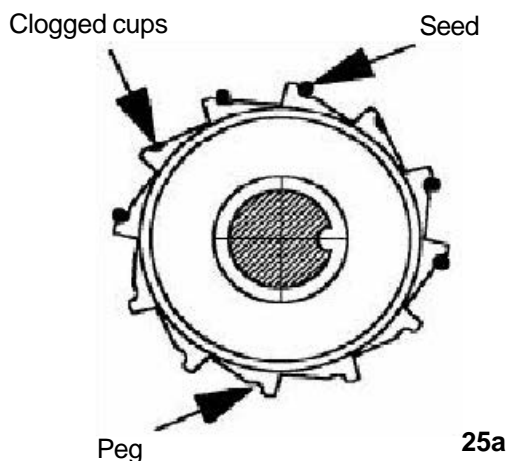

25a

## b) Slide gates

The Slide gates (24/A) have 2 functions:

- Closing and opening the hopper outlets
- Setting the seed stock height at the sowing wheels at the "Reversed rotation position".

Slide gates are not designed to regulate the seed rate!

An incorrect slide gates setting can result in variations in seed rates when sowing on a slope.

### Slide gates settings for "Normal rotation position":

The slide gates must always be **fully opened (24/2)**.

Slide gates closed = position 1 (24/1)

Do not use intermediary settings.

### Shutter settings for "Reversed rotation position":

Here the slide gates on the sowing roller are used to set the seed level.

This slide gates setting depends on how well the seed stock flows. This may be determined by a seed test. (See also page 2 of the Seed Chart)

### Seed Test for "Reversed rotation position":

#### Preparations for seed test:

- Close slide gates
- Fill hopper with seed (rape seed)
- Put emptying trays in place
- Secure slide gate in position **a**
- Bottom flaps remain in position **0**
- Now turn the sowing shaft for at least 10 rotations

#### Seed test procedure:

Catch the seed from one or more spouts while continuing to turn the hand crank until the sowing shaft has made exactly one rotation.

The slide gate setting is correct (**Fig. 25**) when **36 +/- 4** seed kernels are released during one rotation of the sowing shaft.

The seed is not suitable for "Reversed rotation position": if more than **40** seed kernels are released per rotation of the sowing shaft with the slide gate in the position **a**.

If fewer than **32** seeds are counted per rotation, secure the slide gate in the next highest position (first "**b**", then "**c**" or "**d**"). (**Fig. 25**)

**The seed test must be repeated each time.**

#### Important Note:

- After each change of slide gate position, turn the sowing shaft for at least 10 rotations!
- The seed test should also be performed during operation to ensure proper precision planting in "Reversed rotation position".



Clogged cups may sometimes cause a decrease in seed rate. Clean cups with a brush!

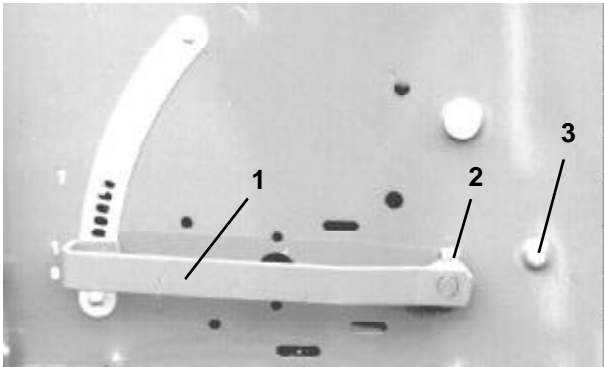

26

### c) Bottom Flap

There are setting-locks 0 - 7 provided for different seed sizes. The correct position is described in the Seed Chart. For positioning use the lever (**26/1**).

If calibration causes stalling or seed breakage, set one lock higher than stated in the Seed Chart.

The correct position for grain, fine seed with reduction fingers and rape in "Reversed rotation position":

use always bottom flap position "0".

The calibration of the bottom flaps in lock position **1** is described under Maintenance.

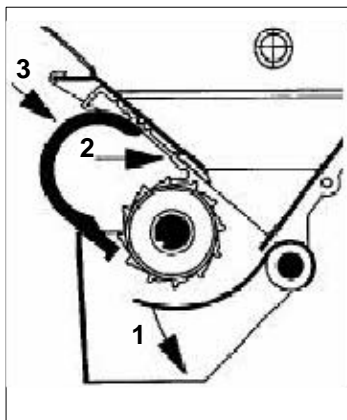

27

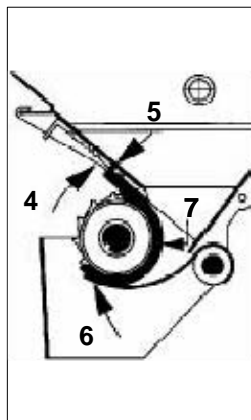

28

### d) Fine Seed Reduction Fingers

Reduction fingers are used for oil seed rape to be drilled in "Normal rotation". For installation see

**Fig. 27+28:**

1. Open bottom flaps in adjustment lever lock position **3**
2. Slide gates in "**open**" position.
3. Mount reduction fingers on sowing wheel (**Fig. 27** and
4. turn towards hopper (**Fig. 28**) until
5. the limiter of the reducer rests against the slide gate.
6. Move bottom flaps to position "**0**".
7. Reach into hopper and press the reducer against the sowing wheel.

The reduction fingers are installed correctly when they rest against the slide gate (**28/5**), and against the bottom flap (**28/6**) as well as the sowing wheel (**28/7**).

Setting for operation:     Bottom flap lock "**0**"  
    Slide gate "**open**"

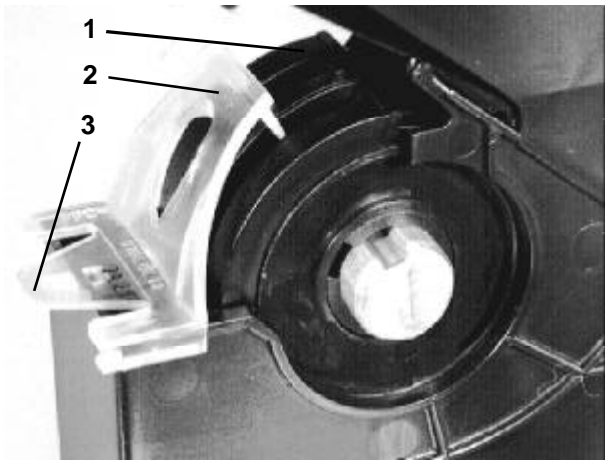

29

**e) Blank-off covers (Optional equipment)**

The covers incl. plastic locks are only installed for "Reversed rotation position" and "Normal rotation position for reduced sowing rates" (29/1+2). When mounting the locks, ensure that they audibly lock in. To remove, (29/3) lift slightly and pull off backwards.

Secure the covers in the correct position with the locks:

- Reversed rotation position – middle groove (30/1)
- "Normal rotation for reduced sowing rates" – back limiter (31/1)

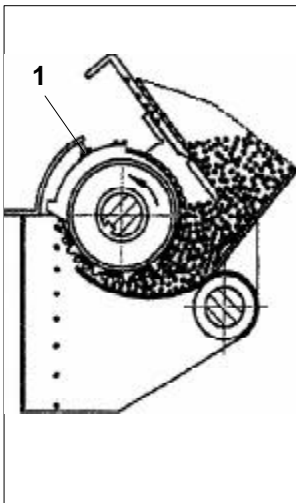

30

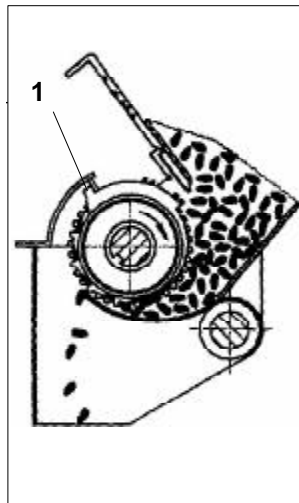

31

**f) Agitator shaft (optional equipment)**

Steep hopper walls and the smooth feed funnels ensure consistent seed flow.

The use of an agitator shaft is only required for extremely bad flowing seed stock only.

There are two types offered:

- Pendulum agitator shaft
- Rotating agitator with fingers

**Pendulum Agitator Shaft – 3 settings**

1. Agitator off – Pin (32/1) in bore (34/0),
2. For non-flowing grass/grass mixture:  
Long swing – Pin in bore (34/1 = same direction as "0"),  
Swinging lever in slot / right against limiter (32/2),
3. For large, clogging seed.  
Short swing – Pin in bore (34/2),  
Swinging lever in slot / left against limiter (33/1),

To change swinging lever setting, loosen both screws (32/3) and re-tighten.

In the "long swing" position, ensure a distance of **6 mm** between the long agitator hooks and the front of the seed casing wall when fully extended (32/4). Fix the agitator elements in the appropriate positions on the shaft.

In the "short swing" position the short agitator hooks will point downwards.

In the "Agitator shaft off" position turn the agitator shaft until the long agitator hooks rest against the front wall of the hopper.

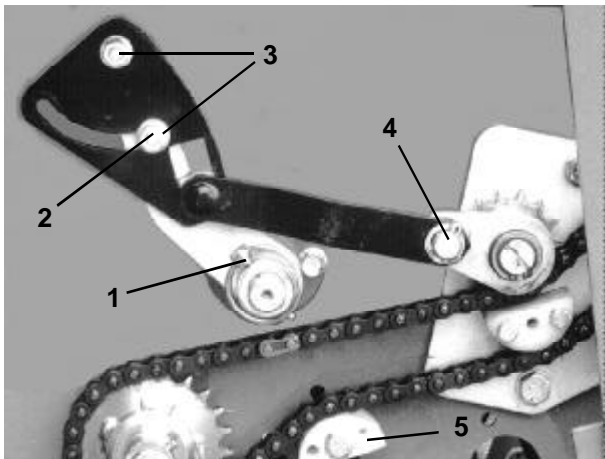

32

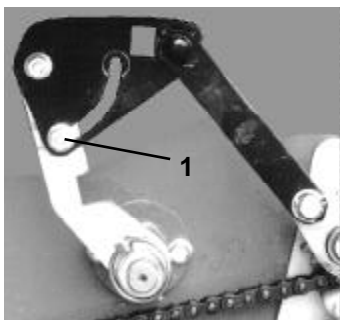

33

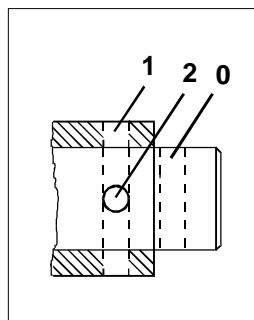

34

### Rotating Agitator

Agitator off - Pin in bore (36/0, 35/0)

Agitator on - Pin in bore (36/1)

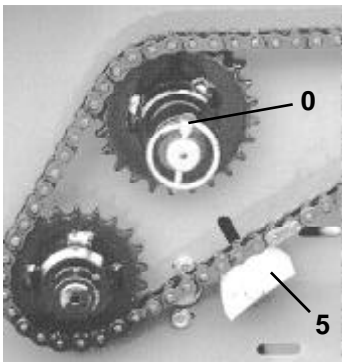

35

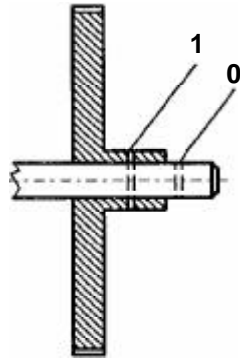

36



*For rape seed, always switch agitator shaft  
Also switch "Rotating agitator" off for grass  
and bring agitator hooks into upright  
position.*

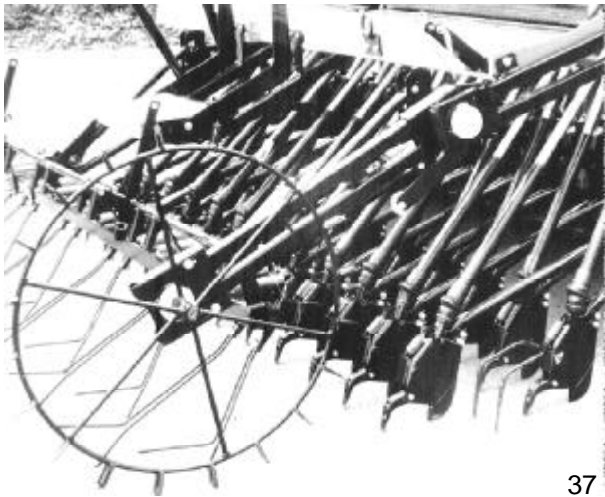

37

### Ground Wheel (Fig. 37)

The sowing shaft is driven by the ground wheel, which runs on the cultivated surface. The pressure with which it presses onto the ground may be set by adjusting the spring tension.

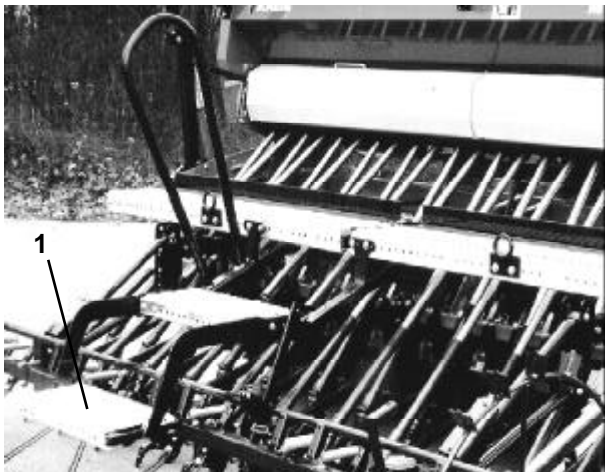

38

### Filling Platform

The filling platform with tread step and handrail facilitates easy filling of the hopper.

Fold up the tread step (38/1) before operation!



**Do not climb onto or ride on the loading platform during operation!  
Keep steps clean!**





40

**Calibration**

As seed varies greatly in specific weight, kernel size, kernel shape and the chemical dressings can vary the values given in the Seed Chart are only a guideline.

For this reason a calibration test must always be performed. In case of deviation, re-calibration is essential by using a different transmission setting.

A correct transmission setting can also be determined without the Seed Chart, using the values of a first calibration test with a random transmission setting. Use the values on the "Seed chart disc" supplied, **Fig. 40**, for the final calibration test.

Example: Set seed rate: 160 kg/ha  
 Calibrated at 120 kg/ha with transmission setting 30

$$160 \text{ kg/ha} = ?$$

$$120 \text{ kg/ha} = 30$$

$$\frac{\text{Transmission setting (30)} \times \text{Set seed rate (160)}}{\text{Calibration seed rate (120)}} = 40$$

(40 is the new correct transmission setting)

Ensure that the seed drill hopper is in an exact level horizontal position. View from the side.

Close unused slide gates / rows.

Tramlining control must not be switched on. All sowing wheels must rotate.

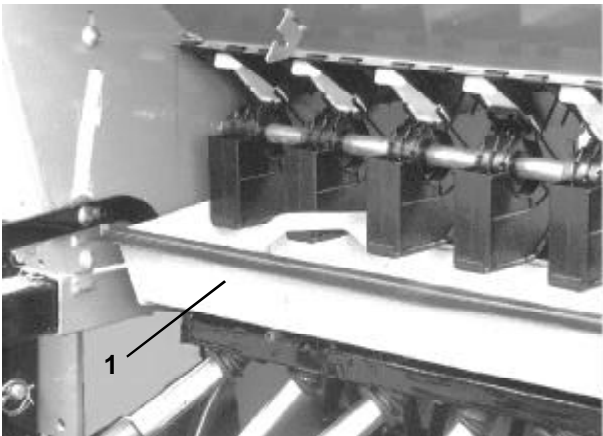

41

**Calibration**

- Transmission setting
  - Slide gates
  - Bottom flaps
  - Blank.off covers/reduction fingers
  - Agitator shaft
- } set according to seed chart!

Place emptying trays on seed pipe rail (**41/1**). Refer to "Emptying" page 8.

Change back after calibration: return seed pipe rail to upright position and lock in.

Hook in emptying trays **42/1** and lock at **42/2**.

Fill the hopper approx. half of the usual amount.

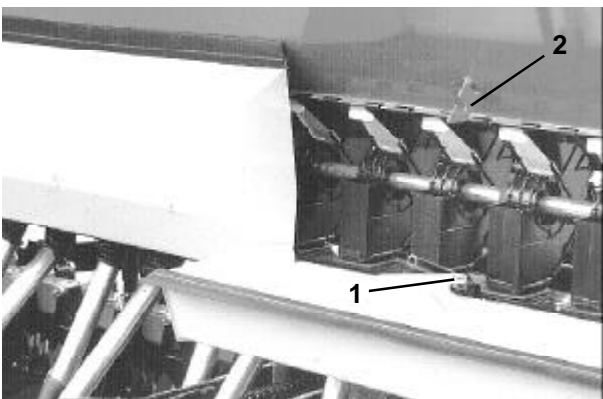

42

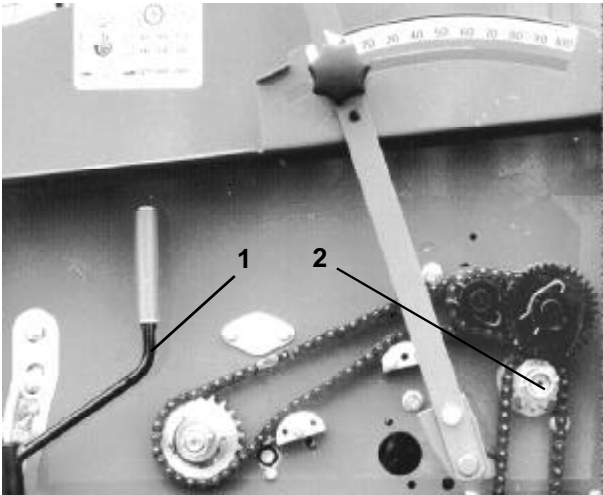

43

Using the hand crank (**43/1** at **43/2**), turn the sowing shaft for approx. 10 rotations to ensure that all sowing wheels are filled and that any dressing residue on the casing walls stabilises the flow.

Empty the emptying trays into hopper.

Now perform the calibration test at the stated rotation for 1/40 or 1/10 ha.

For low seed rates (e.g. rape seed) the calibration test for 1/10 ha is preferable.

**Rotate evenly, approx. 1 rotation per second**

The weighed calibration amount (**weigh carefully**) multiplied by the “area factor” equals the seed rate in kg/ha:

multiply with 40 for 1/40 ha, equals 250 m<sup>2</sup>  
 multiply with 10 for 1/10 ha, equals 1000 m<sup>2</sup>

**Number of hand crank rotations for Calibration Test**

Multidrill A		
Working width	1/40 ha	1/10 ha
2,5 m	<b>93</b>	<b>371</b>
3,0 m	<b>77,5</b>	<b>309</b>
4,0 m	<b>58</b>	<b>232</b>



**Note:** The electronic tramlining control **Multitronic II** has a unique feature „Calibration Aid“. The drill monitor calculates and counts the number of required hand crank rotations for the calibration area selected.

See Operating Instructions for Multitronic II in **appendix A**.

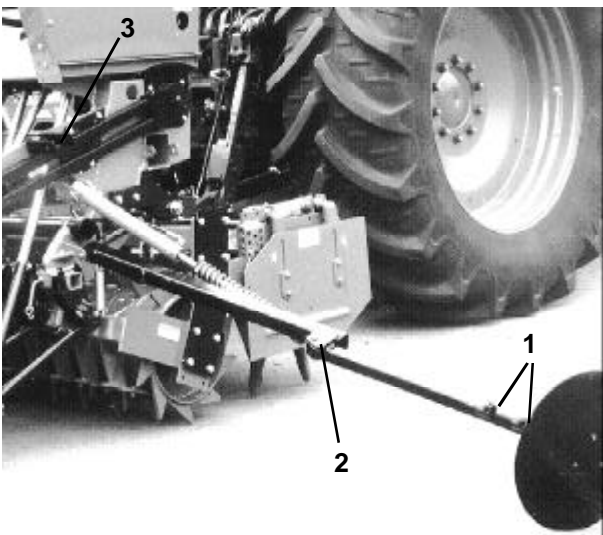

45

**Markers**

The disc markers for 2,5 and 3,0 m width are adjustable for center marking, those of the 4,0 m may be set for centre marking or for wheel marking. As an overload protection the marker arms are equipped with a shearbolt (**45/2**)

Setting: Bring the booms into the operating position. Remove the transport lock (**45/3**) from the holder bracket.

Set the point where the disc touches the ground. Adjust length at (**45/1**).

The length depends on working width and row spacing of the drill as well as the track width of the tractor at wheel marking.

By means of turning the disc axle the penetration angle of the disc can be altered.

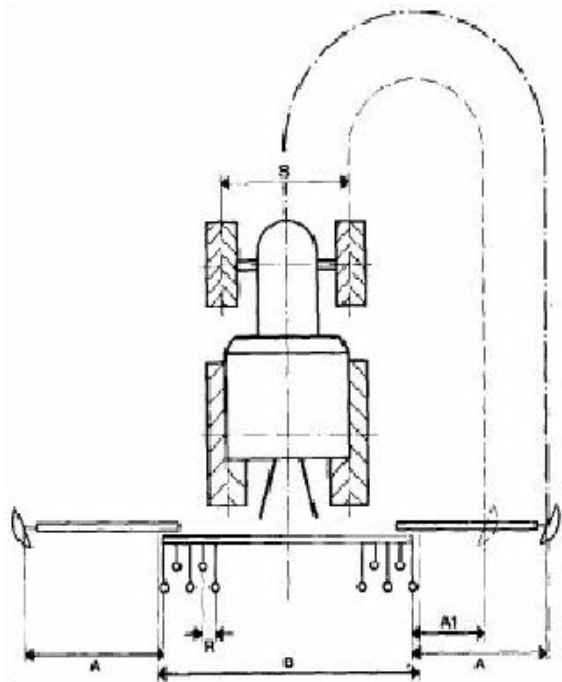

46

### Marking at centre of tractor,

Measured from the outer coulter:

$$\frac{\text{Working width} + \text{row spacing}}{2} = A$$

### Wheel- Marking

Measured from outer coulter:

$$\frac{\text{Working width} + \text{row spacing} - \text{track width of tractor}}{2} = A1$$

Example: 3 m working width (B = 300 cm)  
 12 cm row spacing (R = 12 cm)  
 170 cm track width (S = 170 cm)

$$\frac{B + R}{2} = \frac{300 + 12}{2} = 156 \text{ cm} = A \text{ (Fig. 46)}$$

$$\frac{B + R - S}{2} = \frac{300 + 12 - 170}{2} = 71 \text{ cm} = A1 \text{ (Fig. 46)}$$

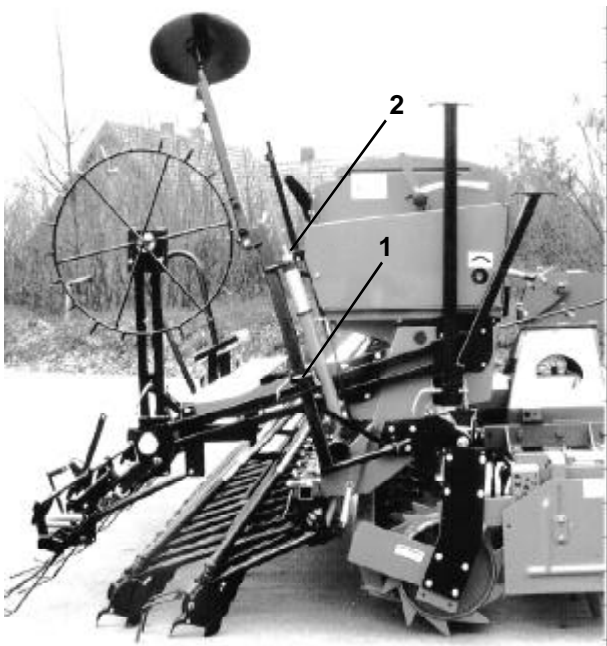

47

The markers are operated using a single-acting spool valve.

Before turning at the headland lift both markers by switching the hydraulic functions on "Raise / Lift"  
 After the turning sequence is finished switch on "Lowering / Down"

**During operation, the hydr. control unit must always be set to "Down" in Float Position.**

Change over and counting impulse for the electronic tramlining control occur when the marker is in its end position during lifting/folding in.

If the marker must be fully folded in during operation because of obstacles, an unwanted counting impulse can be avoided by switching the tramlining button to "OFF" beforehand. Refer to Operating Instructions for Multitronic, appendix A

The maximum lowering point for sufficient working depth of the discs may be set (with lowered boom) on the cylinders with lock nuts (47/2).

Do not turn nuts 47/2 too far to the right. Otherwise the booms may fold in fully before the cylinder is fully retracted.

For transport, fold marker booms in and secure the marker arms (47/1).



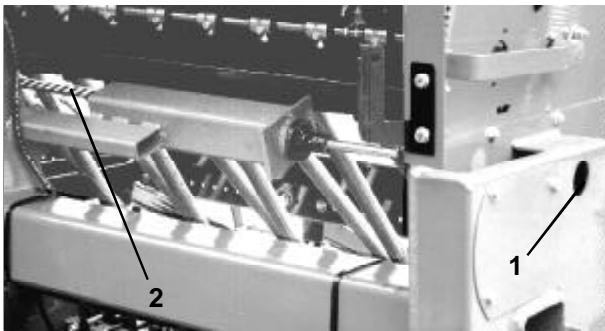

50

### Coulter Pressure Adjustment

The coulter pressure– and thus the seed depth – is continuously adjustable; as (50/1), with hand crank indicated (50/2).

Individual coulters – e.g. in the wheel tracks – may be adjusted to work at a higher pressure by changing the connection point of the spring. Spring in front (52/1) – higher coulter pressure.

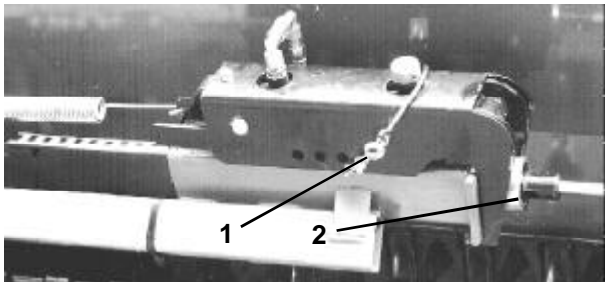

51

### Hydraulic Coulter Pressure Adjustment

This allows for pressure adjustment during operation for varying soil structures.

Set normal pressure at (50/1), pre-select the required “maximum” pressure by inserting the plug into the appropriate socket of the plug gauge (51/1).

A single-acting control unit is required for operation; to reduce pressure to “normal” hold the control unit “Down” for a sufficient length of time (return oil flow).

Fit the hydr. cylinder below the housing.



52



**Warning:** Danger of squeezing at the spindle housing (51/2)!

### Hydraulic Seed Rate Adjustment

It maybe advisable to adjust to maximum seed rate in connection with the hydraulic coulter pressure adjustment.

To operate, switch the 2-way valve to the appropriate setting on the hydr. hose coupling.

Settings “Normal rate” and “Maximum rate”:

“Normal rate”: calibrate as usual. Star handle (21/1, page 10) but set as limiter **behind** the lever (towards 0) – fasten tightly. (Cylinder remains retracted.)

“Maximum rate”: Fully extend the cylinder, select “Max. rate” by moving cylinder at (54/1) and secure with star handle (54/2).

Another calibration test is required.

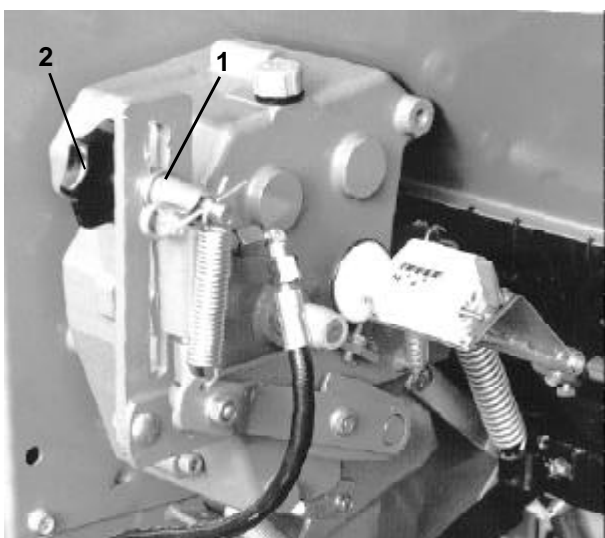

54

**Note:** Do not fix the transmission select lever!

Highest transmission select lever position for “Normal rate” setting = “100” minus required extra amount (plunger length).

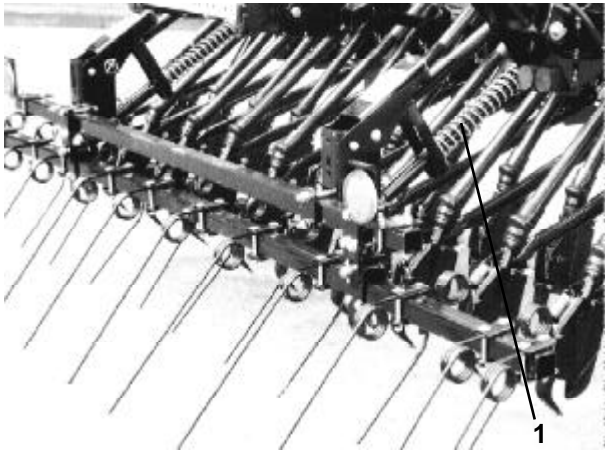

55

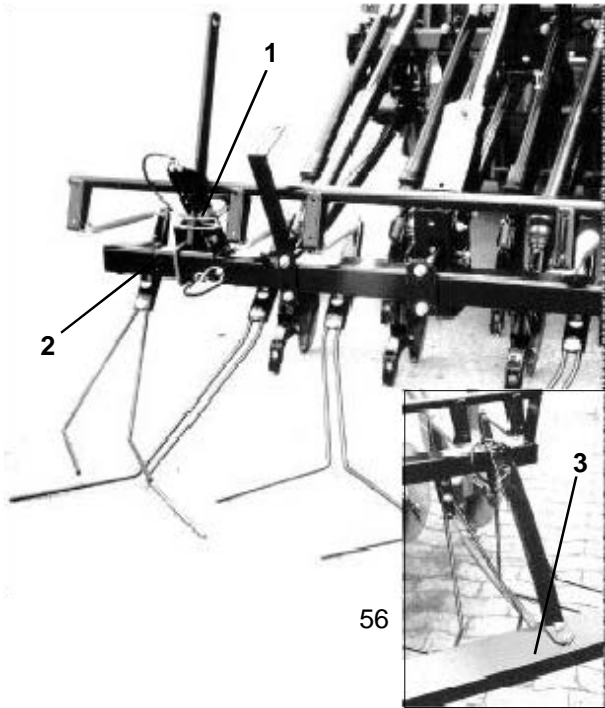

56

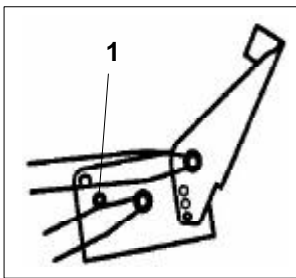

57

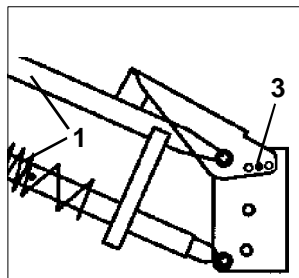

59

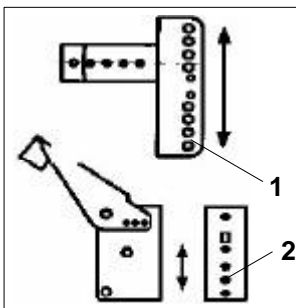

58

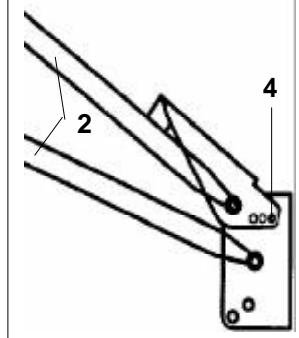

## Rear Harrow Types

**Coulter harrow:** For Suffolk coulters only (61/3). May be attached to the coulters in the rear row. Suitable for light to medium soil, without trash.

**Drag tine harrow:** Two parts, double rows – suitable for all soils.

With spring-adjustable tine pressure:

Turn spring (55/1) to the right – higher pressure, to the left – lower pressure.

To comply with the 3 m legal width on public roads, harrow extensions attached on the left side, must be removed for transport!

Stow harrow extensions in the transport holders provided!

**PERFECT rear harrow:** For all soils and conditions. The individual spring-loaded harrow elements may be centrally adjusted. Select pressure intensity by the placing plug in the appropriate socket of the plug gauge (56/1).

For transport, swing the harrow forwards and downwards and secure with plugs (57/1); or attach the tine guard (56/3) - optional equipment.

**3 m models :** To comply with 3 m transport width, move left harrow elements inwards and secure (56/2).

Ensure correct order of harrows:

Spacing of harrow struts for (58/1),

- drag tine harrow (59/1) – 150 mm
- PERFECT rear harrow (59/2) – 200 mm

Harrow limiter,

- Drag tine harrow – (59/3)
- PERFECT harrow harrow – (59/4)

Height adjustments,

- change both harrow struts to (58/1) move on bracket (58/2)

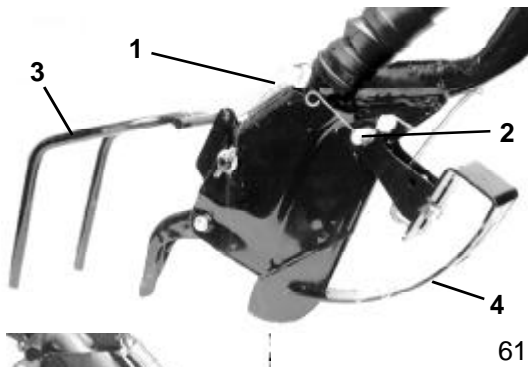

### Coupler Change System

The Suffolk coulters and the band sowing coulters may be exchanged without tools. Unhook the spring (61/1) and pull the spring-secured pin (61/2). Re-secure the pin after mounting.

### Suffolk Coulters (Fig. 61)

For shallow seed placement, adjustable depth limiters (61/4) may be attached. Also retrospectively.



### Band Sowing Coulters (Fig. 62)

An approx. 8,5 cm wide band can be produced with this type of seed coulters. Recommendable e.g. for grass sowing.

Suffok – and band sowing coulters have an anti-clogging-protection. They hinge forward to also avoid bending of the seed tubes while lowering the drill on the ground.

### SAX Single-Disc Coulters (Fig. 63)

Ideal for crop residue with long stalks.

The rotating scraper (63/1) cleans sticky soil off the inner side of the clearing disc (63/2). The curved outer side cleans itself due to the curved design.

The rubber skirt (63/3) prevents the seed from jumping in the furrow.

The pressure of the rotating scraper may be adjusted by screwing the threaded axle (63/4) in or out. Secure the threaded axle with lock nut.

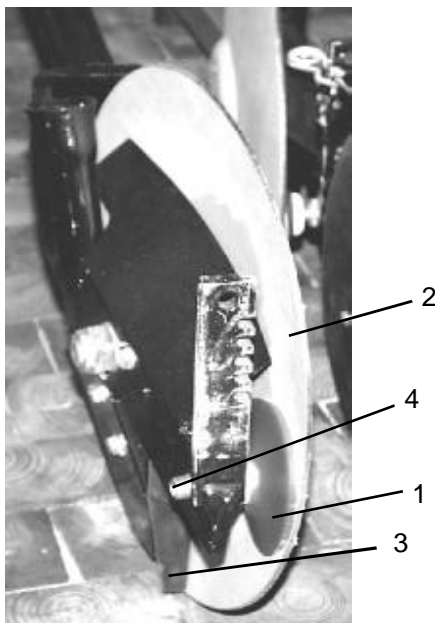

Ensure that the PVC disc of the rotating scraper does not connect in front, as this would produce a braking effect on the disc.

63

### Press Roller (Fig. 64) (Optional equipment)

The design of the press roller (64/1) allows the seeds to be pressed in the furrow or firms the seed furrow on the seeds.

The unit is supplied ex factory with the press rollers mounted on the seed furrow to enable the seed to be pressed.

When mounted to run beside the furrow, the press roller will close the furrow.

For this purpose, the mounting of the roller (64/1) may be changed at its holder (64/2).

Additionally, the press roller serves to act as a depth control for the single-disc coulters. The depth may be adjusted in steps of 1 cm by changing the position of the R-clip (64/3).

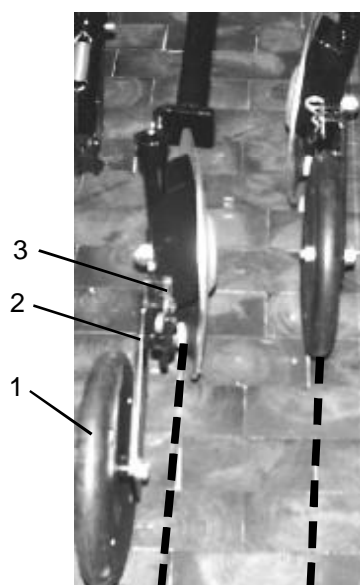

64

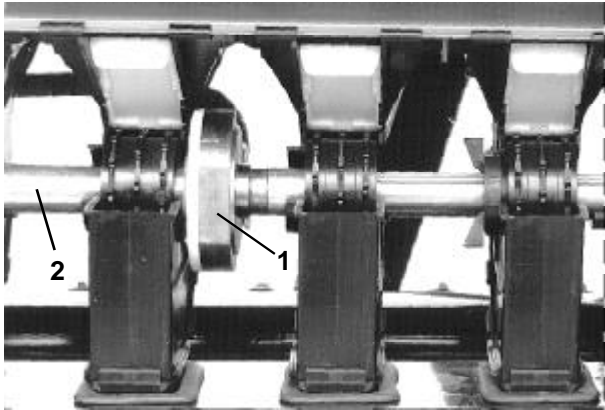

73



### Examples of Tramlines:

See page 23.

At the edge of the field (row marker lowered on field-side) set the tramlining cycle to the correct starting number – e.g. for rhythms 3 and 4 set to 2.

Sensors handle the automatic switching, e.g. when changing the markers.

For **symmetrical** tramlining cycles with even numbers, begin at the edge of the field with  $\frac{1}{2}$  drill working width; switch off the left machine half by disconnecting the pin in the middle of the sowing shaft.

If the fertiliser spreader is equipped with a spread limiter, begin at the edge of the field with full drill working width **and immediately with tramlines**.

Two or three sowing wheels may be switched off per wheel track. As pictured there is a magnetic switch (**73/1**) between sowing wheels and connection sleeves between (**73/2**).

The magnetic switch switches “off” for non-tramlining when it receives power; this ensures that operation may continue for the full number of rows in the case of a power failure. Slide gates may then be closed if necessary.

If not otherwise ordered the drill is supplied with 2 rows tramlining for each wheel mark. To shut-off 3 rows the sowing shaft need to be removed and some sowing wheels and sleeves need to be newly arranged. A assembly instruction can be supplied by the manufacturer.

For **asymmetrical** tramlining, switching occurs only on one single-sided wheel track during each of two passes in opposite directions. Depending on the turn direction chosen, the unneeded magnet on the outer side of the turn must be deactivated by uncoupling.

**Note:** The seed drill is supplied with both magnet couplings connected. For this reason the magnets must be checked after selecting the tramlining rhythm and drive direction!

If no tramlines are to be made but the electronic monitor is to remain active, select rhythm “0”.

For adjusting the tramlining rhythm: see **appendix A, section 5.1.1**

Current operation data is stored so that operation may continue in the correct rhythm after e.g. an interruption.



If the seed drill has been out of operation for a longer period, the tramlining control must be inspected. Check that the sowing wheel connection sleeves (**73/2**) are **not restricted by seed dressing residue** and move easily on the sowing shaft.

When driving on public roads, disconnect all electronic equipment from the on-board power supply. Disconnect plug on tractor side.

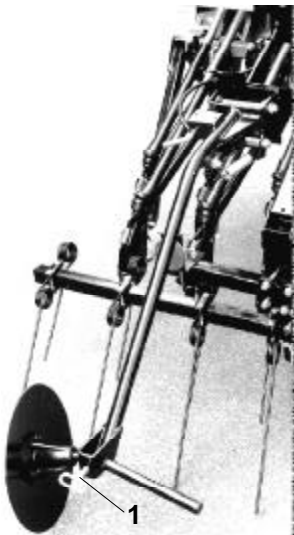

75

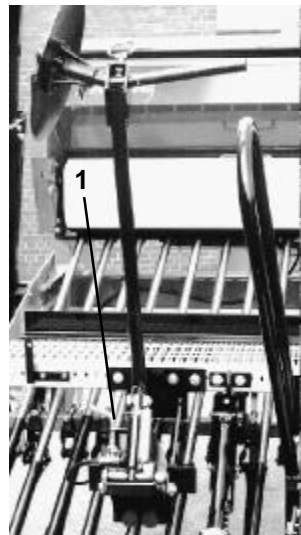

76

### Pre-emergence markers

To be fitted on the filling platform.

Tramlines may be marked for pre-emergence spraying.

The switching is handled automatically. The electromagnetic valve is located on the front end of the machine.

Adjust the disc markers to tramline track-width (**75/1**). To make asymmetrical tramlines in off-set tracks, fold up and secure the unneeded marker.

For transport, the disc booms must be folded up and locked with plug (**76/1**).

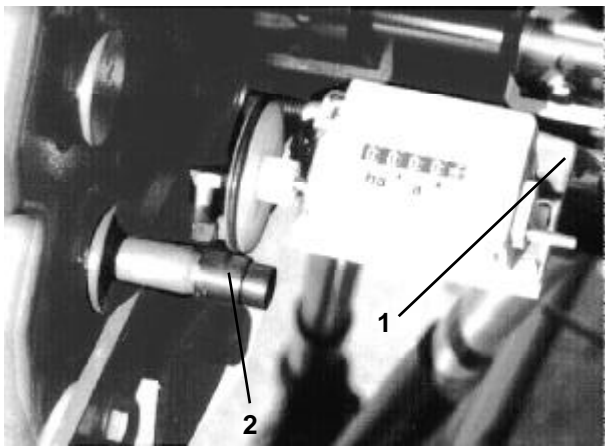

77

### Hectare Meter (if MULTITRONIC is not installed)

The counter begins to count as soon as the ground wheel starts to turn.

Values are given in 1/10 ha and 1,0 ha. Use the lever (**77/1**) to set to "0".

Depending on the machine width, please ensure that the hectare meter is driven by the correct "step" on the driving shaft and that the spring tension is sufficient to hold it in place.

Shaft adapter (**77/2**):  
 Ø 13.6 mm – for 2.5 m width  
 Ø 16.3 mm – for 3.0 m width  
 Ø 21.8 mm – for 4.0 m width



Work. width Seeddrill	Spraying Fertilizing	Rhythm	Examples for tramlines
--------------------------	-------------------------	--------	------------------------

Symmetrical tramlines

3,00 m 4,00 m	9 m 12 m	3	
2,50 m 3,00 m 4,00 m 4,50 m	10 m 12 m 16 m 18 m	4	
2,50 m 3,00 m 4,00 m	12,5 m 15 m 20 m	5	
2,50 m 3,00 m 4,00 m 4,50 m	15 m 18 m 24 m 27 m	6	
3,00 m 4,00 m	21 m 28 m	7	
2,50 m 3,00 m 4,00 m	20 m 24 m 32 m	8	

Onesided tramlines

2,50 m 3,00 m 4,00 m 4,50 m	10 m 12 m 16 m 18 m	4 S	
2,50 m 3,00 m 4,00 m 4,50 m	15 m 18 m 24 m 27 m	6 S	
2,50 m 3,00 m 4,00 m	20 m 24 m 32 m	8 S	

## Operating Instructions



- Bring the seed drill into a horizontal position with little lower link play. Use the top link to bring the upper edge of hopper into a horizontal position
- For operation, set the tractor hydraulics to “Float Position”. That applies also to the marker spool valve.
- Ensure the seed drill is raised high enough on headlands and the PTO- shaft is disengaged if the PTO-shaft starts to rattle.
- To prevent the coulters from clogging, lower the seed drill in the field only while driving away. Not in a standing position.
- Adjust the driving speed to suit the conditions to ensure that the seed is placed at a consistent depth. Operation at up to approx. 12 km/h can be tolerated in favourable conditions when the seed drill is mounted on a cultivator harrow.



- Check all settings such as the calibration test, kind of sowing system, slide gates, bottom flaps, transmission setting and if emptying trays are folded up and are in locked position.
- While beginning to drill and then at regular intervals, **ensure that all coulters are sowing and not clogging** and that the seed rate is correct.
- Seed dressing residue may hinder the seed flow. It is therefore useful to perform another test calibration after approx. 2 hopper loads.
- No liability will be accepted for deviations in seed quantity or damages resulting from clogging.



- Ensure that the marker settings and the tramline rhythm, including sowing wheel stop, are correct.
- Check the distance from the bottom edge of the coulter rail to the ground is approx. 44 cm.
- Never fill the hopper unless it has been hitched and always empty before unhitching.
- When filling, ensure that no foreign materials (bits of paper, sack tags) enter the hopper.
- Keep the hopper lid closed.
- Observe the seed level using the level indicator and ensure even distribution.
- For operation, fold up the collapsible tread step on the loading platform.
- Given the hygroscopic nature of the seed including dressing, always empty the hopper when not in use for long periods.



Please note that seed dressings are irritants and may be poisonous!



## Maintenance

Before working on the hitched machine, turn off the engine and remove ignition key!

Do not work on a raised seed drill!

If working on a raised drill is necessary, use additional safety supports to prevent unintentional lowering!

De-pressurize the hydraulic system before commencing any work!

Ensure proper disposal of oil! The hydraulic oil is mineral based.

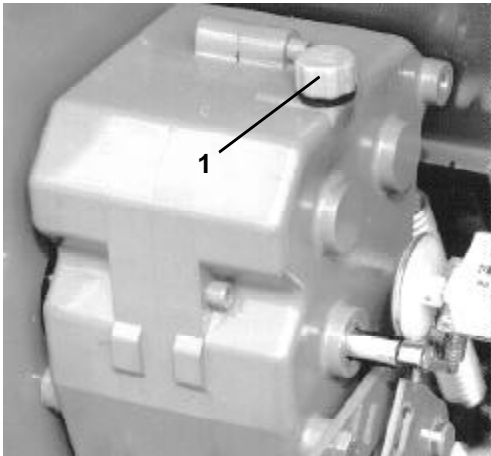

78

### Retighten all bolts after initial operation (approx. 8 hrs), then check at regular intervals.

Grease all bearings, including the disc bearings of the markers and pre-emergence markers approx. every 50 working hours. Use grease which is lithium-based multi-purpose grease.

Check the oil level in the transmission by means of oil stick (**78/1**). It is a permanent fill. The filling quantity is 2.5 Liter of hydraulic oil HLP 32.

Grease chain drives.

Maintain the movement of joints, spindles and sowing wheel sleeves (**73/2**) for tramline control). But do not oil the sowing shaft or seed-pipes.

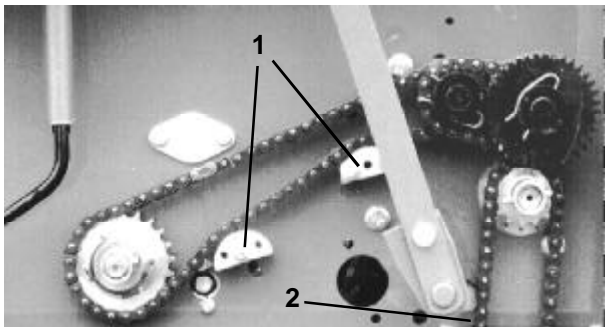

79

Retighten the chain drives at (**79/1+2**), or, for agitator shaft see pages 13+14 (**32/5** or **35/5**); Loosen the bearings on the ground wheel (**80/1+2**) and tighten manually and retighten the screws afterwards again carefully.

For disc coulters, keep the discs clean and check the scrapers.

Check the hydraulic hoses at regular intervals and replace if damaged or worn (see Spare Parts List). Hoses deteriorate naturally with age. Do not use for more than 5-6 years.

When cleaning with a water jet (especially high-pressure), do not point directly at electrical components e.g. magnet couplings, cable connections or bearings, e.g. single-disc coulters bearings.

Retouch any damage to paint.

Use a damp cloth and mild household detergent to remove any dirt on the "Multitronic" keyboard. Do not immerse the casing in liquid!

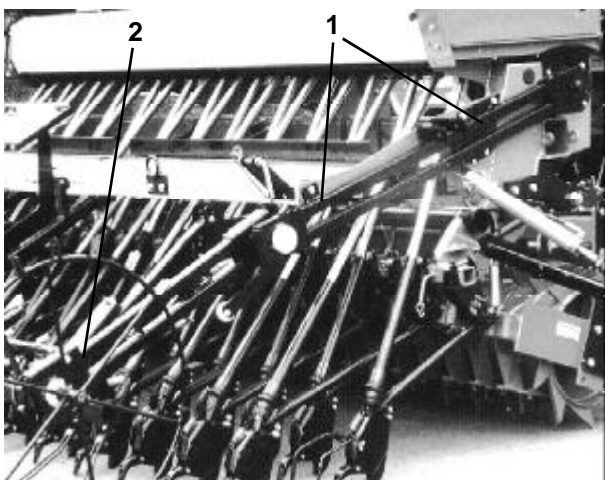

80

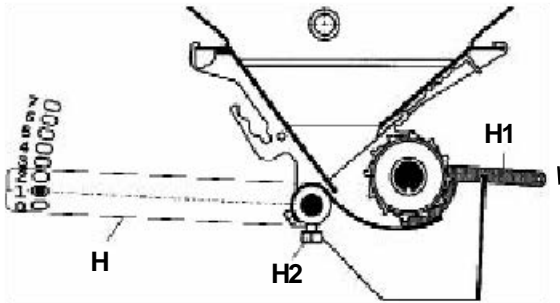

81

**Calibration of bottom flaps:** Before commencing sowing and with empty hopper, use the calibration gauge (71/H1) to check the settings of all the bottom flaps. Set the bottom flap adjustment lever (81/H) to „1“ position and turn the sowing shaft until the groove points downwards.

Slide the adjusting gauge alongside the middle row of pegs of the sowing wheel from the top downwards between the sowing wheel and the bottom flap – until the handle of the calibration gauge rests on the sowing box.

The calibration gauge must fit without any play. Otherwise slacken the screws to make any readjustments

(81/H2) and then retighten in the correct position ensuring there is no play.

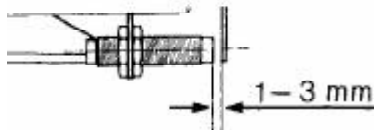

82

**Setting of Sensors:** The sensors are spaced 1-3 mm apart (Fig. 82).

An operation control (LED) has been integrated into the sensor, giving a visible indication of whether the sensor is working during corrective adjustments or test runs. See also section Sensor Testing - Operating Instructions for MULTITRONIC.

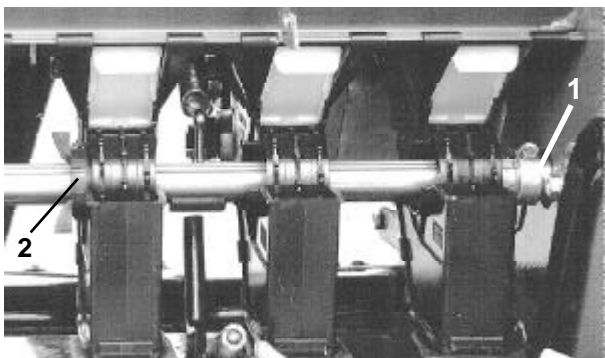

83

**Removal of Sowing Shaft:** Open the slide gates and, after loosening and moving the ring (83/1), rotate the shaft in such a way that the clutch on the right hand side is more or less horizontal. Turn the bearings (83/2) to the right (90°), press ratchet lock and slide to one side.

Remove the shaft to the rear. Follow the instructions in reverse order to mount the shaft.

Replace the bearings and rotate 90° to the left. Lock the ring (83/1) in place above the clutch. Ensure that any side play of the sowing shaft is restricted by a limiter screw (26/3, page 12).



When performing welding work on the tractor or an attached machine and when charging the tractor battery or connecting a second battery (jump start) always disconnect from the electronics box.

## General Transport Instructions



Bring machines into transport position; ensure suitability for transport.

Before driving on public roads, disconnect the electronic control box MULTITRONIC from the power supply (remove plug from tractor socket).

Riding on the machine or standing in the danger area is not permitted.

Adjust the transport speed to suit the road conditions.

Caution on bends: hitched implements swing outwards!

Any applicable road safety regulations must be observed. The operator is responsible for the safe coupling of the tractor and machine when driving on public roads.



Machinery must not compromise the safe driving of the tractor. Permissible axle-loads, total weight, and tyre load capacity (depending on speed and air pressure) must be adhered to. For safe steering, the load on the front axle must be at least 20 % of the dead weight of the vehicle.

The highest permissible transport width is 3 m. Special permission is required for over-wide machines.

Transport 4 m combination machines on a low-loader.

Ensure that protruding parts at the outline of the machine do not pose a danger to traffic. If this cannot be avoided, these parts must be covered and clearly marked. The outline and back of the machine must also be made clearly visible – e.g. use red/white striped warning signs 423 x 423 mm (DIN 11030; 100 mm wide strips, at a 45° angle running outwards/downwards).



Light fixtures are necessary if hitched machinery obstructs the tractor lights or when required by the weather conditions. Also mount lights at the front and back when the hitched machine extends more than 40 cm over the tractor lights, or at the back, if the distance between the tractor tail-lights and the machine is greater than 1 metre.

Required warning signs and light fixtures should be bought from the respective dealers.

For transport on a low-loader, attach warning signs, red tail-lights and yellow side reflectors to the low-loader. Always drive with lights switched on – even in daylight.





Operating instructions

*Seed drill monitor*

*Multitronic II for*

*Multidrill eco / eco-line*

*Multidrill eco A / eco-line A*



## Multitronic II – Seed drill monitor for MULTIDRILL

<b>Contents</b>		<b>Page</b>
1)	General information	1
2)	Operating features of the seed drill monitor	2
2.1)	Electrical connection	2
2.2)	Technical data	2
2.3)	Operating functions	2
3)	Starting the seed drill monitor for the first time	3
4)	Quick startup instructions for the MULTIDRILL	3
4.1)	Control panel of the Multitronic II seed drill monitor	3
4.2)	Readout pushbuttons	3
4.3)	Alarm functions	3
4.4)	Main menu (quick guide)	4
5)	Multitronic II main menu for MULTIDRILL	5
5.1)	Default settings	5
5.1.1)	Tramline rhythm	5
5.1.2)	Operating width	5
5.1.3)	Calibration of the hectare meter or entry of wheel impulses	5
5.1.3.1)	Calibration of the hectare meter	5
5.1.3.2)	Entry of wheel impulses	6
5.1.4)	Sowing shaft monitoring	6
5.1.5)	Hopper level monitoring	6
5.1.6)	Delay time	7
5.1.7)	Saving the machine settings	7
5.2)	Sensor test	8
5.3)	Calibration assistance	9
6)	Display (readout) pushbuttons	9
6.1)	Hectare meter	9
6.1.1)	Partial / total surface area counter display	9
6.1.2)	Partial hectare meter reset	10
6.1.3)	Partial surface area and total hectare meter reset	10
6.2)	Drive speed display	10
6.3)	Sowing shaft turning speed display	10
6.4)	Tramline cycle	10
6.5.1)	Tramline cycle display / adjustment	10
6.5.2)	Automatic relaying interruption	10
7)	Alarm functions	11
7.1)	Sowing shaft alarm	11
7.2)	Hopper level alarm	11
8)	Configuring for machine type and local language	12

### 1) General information

In order to avoid operating and adjustment errors, please read the following references and explanations thoroughly before operating the unit.

## 2) Operating features of the seed drill monitor

### 2.1) Electrical connection

Power is supplied to the seed drill monitor from the tractor's 12V electrical system via a DIN 9680 plug connection. These three-pin plugs also exist in two-pin format, as only the two main terminals (+12V, earth) are required here.

On request, the seed drill monitor can also be fitted to operate via an ISO 11786 signal socket.

### 2.2) Technical data

Operating voltage: +10V .....+15V

Power consumption of the seed drill monitor 70 mA

Operating temperature range: -5°C ..... +60°C

Storage temperature -25°C .... +60°C

Protection rating IP65

Fuse 6A multi-fuse in power supply plug

The circuit breaker resets itself automatically, once the short circuit has been dealt with and after a delay period of approx. 2 min has passed.

LCD unit: Four-line back-lit display

### 2.3) Operating functions

The Multitronic II seed drill monitor is a compact on-board computer, which carries out a number of useful functions. It helps run important control and monitoring functions, providing practical display and system utility functions designed to simplify operation and save work.

The monitor is designed as a highly versatile unit, suitable for trouble-free application throughout both the "MULTIDRILL ME/MEL" range of mechanical seed drill machines and the "TURBODRILL" range of air-operated units.

There now follows a brief overview of these operating functions:

#### Control functions:

- Tramline setup
- Additional tramline marking setup
- Automatic or manual relaying of tramline cycles
- Interruption of automatic relaying of tramline cycles driving in order to drive around obstacles

#### Display functions:

- Tramline cycle and tramline rhythm display
- Partial surface area hectare meter
- Total surface area hectare meter
- Drive speed
- Sowing shaft revolutions

#### Monitoring functions:

- Sowing shaft monitoring
- Hopper level monitoring

#### System utility functions:

- Sensor test
- Calibration assistance for calculation and inclusion of crank handle revolutions
- Calibration of hectare meter (adaptation of hectare meter to ground conditions)
- Adjustable time delay for automatic relaying of tramline cycle
- Menu language selection in English, German or French



E - EL

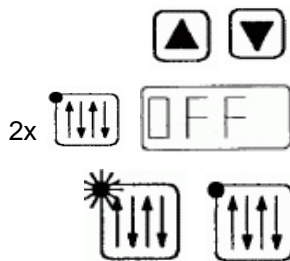
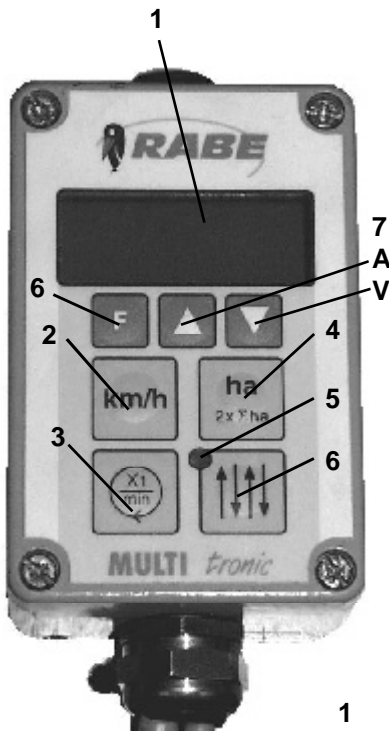

Err1

Err2

### 3) Starting the seed drill monitor for the first time

The Multitronic II seed drill monitor is activated by inserting the power supply plug in the socket. A short horn signal indicates that the unit is active. The display is then active for about two seconds, to show the type of machine in use: **<E-EL>** for the MULTIDRILL ME/MEL range of units or **<turb>** for the TURBODRILL range of units.

Displays can now be activated for drive speed, hectare meter, sowing shaft revolutions or tramline circuit.

**<E-EL>** should be displayed for the **MULTIDRILL** range.

**<turb>** should be displayed for the TURBODRILL range.

If the wrong type of machine is displayed, the unit must be readjusted according to machine type (see sect. 8) before the seed drill monitor can operate correctly.

### 4) Multitronic II quick startup instructions for the MULTIDRILL

#### 4.1) Control panel of the Multitronic II seed drill monitor

Readout/Display (1/1), Function key Drive speed (1/2), Sowing shaft revolutions (1/3) Hectare meter (1/4), LED (1/5), Tramline (1/6), Arrow keys (1/7, A,V) und F-Taste (1/7)

#### 4.2) Readout pushbuttons

The green keys are readout pushbuttons

##### Drive speed indicator (1/2)

Push once to readout drive speed

##### Readout Hectare meter (1/4)

Push once to display partial surface area hectare meter

Push twice to display total surface area hectare meter

To reset the partial surface area hectare meter, press both arrow keys **A** and **V** for 2 sec.

To reset both hectare meters, press the two arrow keys **A** and **V** for 10 sec.

##### Display Turnings (1/3)

Press once to display sowing shaft revolutions

##### Tramline cycle and Tramline rhythm indicator (1/6)

Use the arrow keys **A** or **V** to alter the tramline cycle manually.

Press twice to switch **<OFF>**

LED (1/5) ON = tramline active

LED (1/5) OFF = tramline inactive

#### 4.3) Alarm messages

**<Err1>** = Sowing shaft monitoring alarm

**<Err2>** = Hopper level monitoring alarm

#### 4.4) Main menu

Press the **F** function key to activate the main menu.

The seed drill unit is now running with its default settings <AdJU>. This operation also activates the system utility functions sensor test <SEns> and calibration assistance <CAL>.

#### Quick guide Multitronic II MULTIDRILL

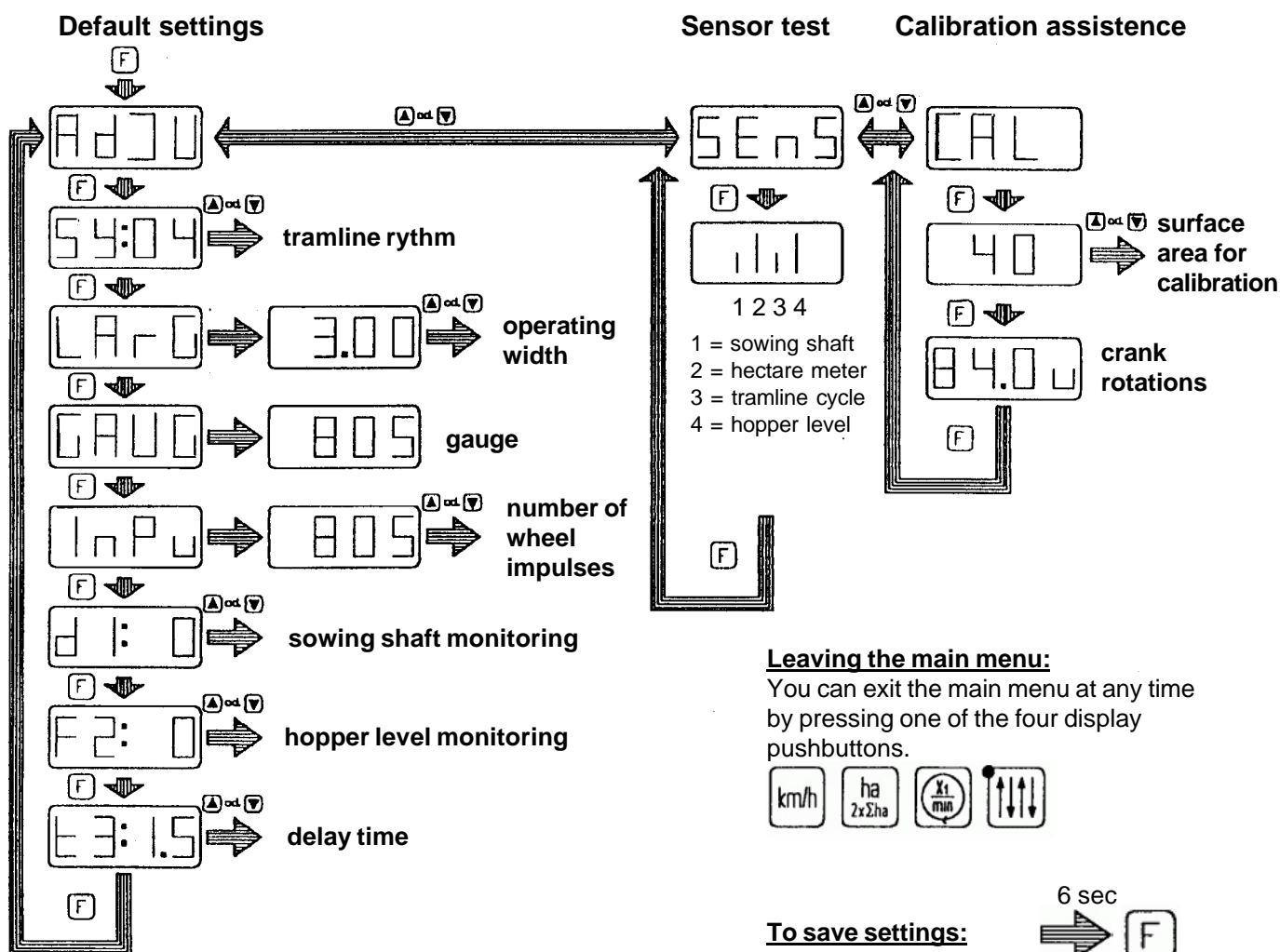

#### Leaving the main menu:

You can exit the main menu at any time by pressing one of the four display pushbuttons.



#### To save settings:

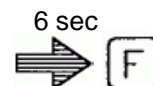

Keep the **F** key pressed for 6 sec. The display will start flashing after 2.5 sec and an acoustic signal will sound after 6 sec. When the sound stops, the setting is saved and the **F** key can be released. If the **F** key is released any earlier, the old setting will be retained.

Please refer to the operating manual for further information.

F AdJU

▲ SENS

▼ CAL

AdJU

F ▲ ▼ F

59:04

AS:06

FG:00

▲ ▼ F

LARG

3.00

▲ ▼ F

GAUG

805

## 5) Multitronic II main menu for MULTIDRILL

Three different functions can be activated via this menu:

Seed drill unit default settings <AdJU>

Sensor test <SENS>

Calibration assistance <CAL>

Press the **F** key and use arrow key **A** or **V** to select the desired function. Press the **F** key again to activate the selected function.

### 5.1) Default settings

The default settings must be established before the seed drill monitor can be used for the first time. This operation allows the seed drill monitor to receive data on the configuration of the seed drill unit.

**Erroneous default settings lead to functioning errors and incorrectly calculated readouts.**

Press the **F** key and use **A** or **V** to select the default setting. Press the **F** key again to activate the default setting.

This operation displays the tramline rhythm setting.

#### 5.1.1) Tramline rhythm

This menu allows adjustment of the symmetric and asymmetric tramline rhythms, or deactivation of the tramline circuit.

Symmetric tramline rhythms:

<SY:02>, 03, 04, 05, 06, 07, 08, 09, 10, 11, 12

Asymmetric tramline rhythms:

<AS:02>, 04, 06, 08, 10, 12

Deactivated tramline circuit: <FG:00>

Use **A** or **V** to select the tramline rhythm and press **F** to save. (See sect. 5.1.7)

The next stage is adjustment of the seed drill unit operating width

#### 5.1.2) Operating width

The operating width symbol <LARG> is now displayed and, after three seconds, the previously set operating width.

Use **A** or **V** to select the operating width and press **F** to save. (See sect. 5.1.7)

The following stage is hectare meter calibration.

#### 5.1.3) Calibration of the hectare meter or entry of wheel impulses

An impulse count for an operating length of 100 m is required for accurate hectare metering and correct drive speed display.

This can be determined in two different ways:

Entry of wheel impulses using the table

Or by taking an actual reading of the number of impulses

The table value should always be entered first. Calibration of the hectare meter should only be carried out if the unit is giving inaccurate readings.

##### 5.1.3.1) Calibration of the hectare meter

Calibration of the hectare meter involves adapting it to the ground conditions of the land being cultivated. This operation should only be carried out if the unit is giving inaccurate readings. Calibration is carried out directly in the field.

The calibration symbol <GAUG> will appear first, followed after 3 seconds by the previously set wheel impulse count.

### Stop calibration:

If you need to stop the calibration procedure, or carry it out later, briefly press the **F** key. The program will then jump directly to the next adjustment setting menu, wheel impulses <InPu>.

### Calibrating the unit:

Proceed as follows if calibration is required:

Drive the machine to the beginning of the field test section.

Measure out a 100 m stretch of field

Press arrow key **A** to display a zero

Drive along the test section. The seed drill monitor will now total up the number of hectare meter impulses.

After reaching the end of the test section, press arrow key **V** and the seed drill monitor will stop recording the number of impulses.

Press the **F** key to save the impulse reading. (See sect. 5.1.7)

The program will now move on to the next adjustment setting menu: wheel impulses <InPu>.

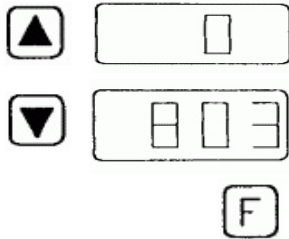

### 5.1.3.2) Entry of wheel impulses

The wheel impulse symbol <InPu> will be displayed first, followed after 3 sec by the previously set impulse count.

In the case of the MULTIDRILL, impulse count depends on the size of the drive wheel:

MULTIDRILL	Impulse count / 100 m
Tyre 6.00-16	805
Tyre 10.0/75-15.3	762
Ground wheel	743

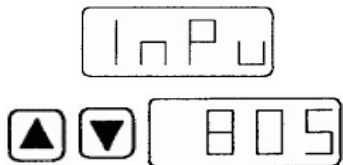

Use arrow key **A** or **V** to select impulse count and press the **F** key to save. (See sect. 5.1.7)

The following step is sowing shaft monitoring adjustment.

### 5.1.4) Sowing shaft monitoring

Sowing shaft monitoring is enabled or disabled in this menu.

Sowing shaft monitoring on = <d1: 1>

Sowing shaft monitoring off = <d1: 0>

Use arrow key **A** or **V** to enable or disable the monitoring function and press the **F** key to save. (See sect. 5.1.7)

The following step is hopper level monitoring adjustment.

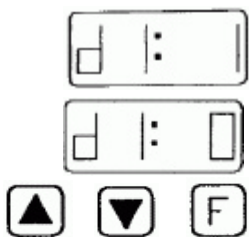

### 5.1.5) Hopper level monitoring

This menu is used to enable or disable hopper level monitoring.

Hopper level monitoring on = <F2: 1>

Hopper level monitoring off = <F2: 0>

Use arrow key **A** or **V** to enable or disable the monitoring function and press the **F** key to save. (See sect. 5.1.7)

The following step is delay time adjustment.

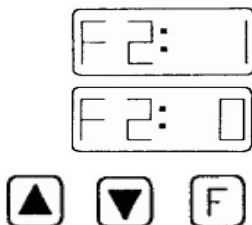

### 5.1.6) Delay time

Delay time **t3** (t=time) involves delaying the switching impulses for automatic relaying of the tramline cycles. The purpose of this function is to avoid incorrect activation. Delay time is adjustable between 0.5 sec and 7.0 sec, steps of 0.5 sec.

The following values should be entered before operating the unit.

<u>Automatic relaying via:</u>	<u>Display readout (= delay time in sec)</u>
Automatic marker arm sensor	1.5
Shuttle valve pressure switch	1.5
Hydrolift sensor	1.5
Fendt signal plug socket	1.5
Ground wheel sensor	4.0
Level compensator sensor	4.0

Other values can also be entered however. Use arrow keys **A** or **V** to select delay time and press the **F** key to save. (See sect.5.1.7)

The seed drill unit default adjustment setting procedure is now complete. The program will now return to the main menu and the default setting symbol <AdJU> will be displayed once more.

Press any of the four green display pushbuttons to exit this menu.

### 5.1.7) Saving the machine settings

If the pre-set default settings are altered, they must be saved to memory.

All settings can be saved in the same way:

Keep the **F** key pressed for 6 sec.

The display will start flashing after 2.5 sec and an acoustic signal will sound after 6 sec.

When the sound stops, the setting is saved.

The **F** key can now be released, giving automatic access to the following menu.

If the **F** key is released early, access is gained to the following menu, but any new setting that may have been entered will be ignored and the previous setting retained.

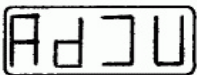
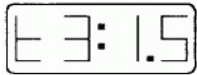

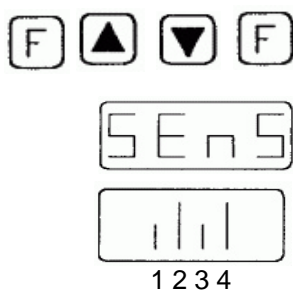

## 5.2) Sensor test

The sensor test offers a method of testing the function of the seed drill unit sensors.

Press the **F** key and use arrow keys **A** or **V** to select the sensor test function, then press the **F** key again to start the test.

A four-bar display will now appear:

- 1=Sowing shaft monitoring
- 2=Hectare meter
- 3=Tramline cycle relaying
- 4=Hopper level monitoring

Each bar shows the activation status of its corresponding control function.

For sowing shaft monitoring, hectare meter and hopper level monitoring (sensors with opening function):

- Long bar = no metal detected
- Short bar = metal detected

Tramline cycle relaying via

Automatic marker arm, Hydrolift or level compensator sensor (Sensors with opening function)

- Long bar = no metal detected
- Short bar = metal detected

Shuttle valve pressure switch

- Long bar = Switch under pressure
- Short bar = Switch pressure released

Fendt signal plug socket

- Long bar = lifting gear raised
- Short bar = lifting gear lowered

Ground wheel sensor (sensor with closing function):

- Long bar = metal detected
- Short bar = no metal detected



You can test the functioning of a sensor by holding a metallic object (e.g. a screwdriver) in front of the it and then moving it away again.

Pressure switch functioning, with closed hydraulic circuit, can be tested by raising the marker arms.



When the sensor test is over, press any one of the four green display pushbuttons to leave the menu.



CAL

40



167.0

79.50

5.00

0.00

-1.00

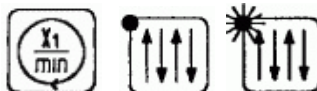

ha 2xΣha 5.06

ha 2xΣha 10.48

### 5.3) Calibration assistance

Calibration assistance is a system utility for the seed calibration test. This function computes the number of crank rotations, showing them on the display, and also counts the number of crank rotations during the calibration test.

Press the **F** key and use arrow keys **A** or **V** to select calibration assistance <CAL>. Press the **F** key again to activate the function.

The following choice of surface areas for calibration will now be displayed:

- 1/10 ha            display <10>
- 1/20 ha            display <20>
- 1/40 ha            display <40>

Use arrow keys **A** or **V** to select the size of surface area to be calibrated and confirm the selection by a short press on the **F** key.

The seed drill monitor will now compute the number of crank rotations and display the figure. During this operation, values greater than 100 revolutions are displayed as whole figures. Values under 100 revolutions are shown exactly to the nearest half-turn.

The calibration test can now start. The seed drill monitor will now count the number of hand crank rotations, starting from the displayed value and running in reverse, thus providing a constant display of the crank turns that remain to be carried out. The final five turns of the crank are accompanied by an additional acoustic signal, in order to warn the operator of the impending end of the calibration procedure.

Once the value reaches zero <0> a constant acoustic signal is activated to warn the operator to stop calibration immediately.

If calibration does continue, the display will show the corresponding negative value and the constant acoustic signal will continue to be heard until no more impulses are being detected at the hectare meter.

To repeat the calibration test: press the **F** key, the calibration test will restart from the beginning.

To stop the calibration test, press any one of the four green display pushbuttons to leave this menu.

### 6) Display (readout) pushbuttons

The green keys are the display pushbuttons, which are used to operate the following functions:

- Display / reset hectare meter
- Display drive speed
- Display sowing shaft revolutions
- Display / alter tramline cycle

#### 6.1) Hectare meter

The seed drill monitor operates via two separate hectare meters: namely a partial area meter and a total surface area meter.

Data are displayed as follows, with floating decimal point:

0.00 – 9.99    10.00 – 99.99    100 – 999    1000 – 9995

##### 6.1.1) Partial / total surface area meter display

Press the display key to show the partial surface area count.

Press the display key again and the total surface area count will appear for 5 sec, followed once more by the reading for the partial surface area hectare meter.

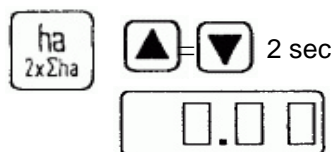

### 6.1.2) Partial hectare meter reset

Press the display key to show the partial surface area meter. Now press both arrow keys **A** and **V** at the same time and maintain pressed for 2 sec. The display will now start flashing and will reset to zero <0> after a further 2 sec, when it will stop flashing. This completes the reset procedure.

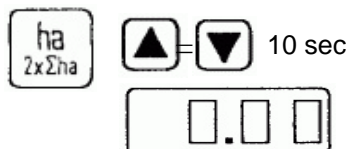

### 6.1.3) Partial surface area and total hectare meter reset

Press the display key again to show the total hectare meter. Now press both arrow keys **A** and **V** at the same time and maintain pressed for 10 sec. The display will now start flashing and will reset to zero <0> after a further 10 sec, when it will stop flashing. This completes the reset procedure.



### 6.2) Drive speed display

Press the display key to show drive speed in km/h.



### 6.3) Sowing shaft revolutions display

Press the display key to show sowing shaft revolutions as a rotating <0>.

### 6.4) Tramline cycle

The tramline cycle can be displayed and altered, with tramline cycle relaying being carried out either automatically or manually. It is also possible to interrupt automatic relaying, when avoiding obstacles for example, without altering the tramline cycle itself.

#### 6.4.1) Tramline cycle display / adjustment

Press the display key to show the tramline cycle and rhythm.

Left : **Tramline cycle**

Right : **Tramline rhythm**

Please refer to sect. 5.1.1 for details of tramline rhythm adjustment.

Tramline cycle relaying:

The tramline cycle is automatically relayed by means of sensors or pressure switches, although it can also be activated manually.

Use arrow keys **A** or **V** to alter the tramline cycle

Once a tramline is established, the red LED in the tramline display key will light up.

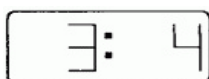
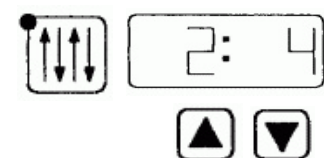

#### 6.4.2) Automatic relaying interruption

Press the display key again to make <OFF> appear. This operation interrupts automatic relaying of the tramline cycle. It is now possible to operate the marker arms or raise the seed drill unit, without relaying the tramline cycle. The tramline can now also be directly activated or deactivated:

Tramline ON: press arrow key **A** (LED lights up)

Tramline OFF: press arrow key **V** (LED goes out)

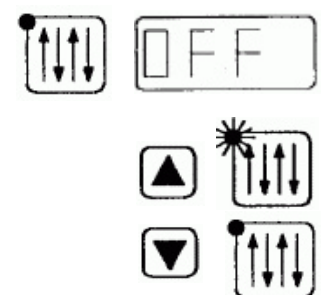

Press the display key again to return to normal tramline cycle relaying. The tramline cycle that was active before the interruption will now reappear on the display.



## 7) Alarm functions / messages

Seed hopper level and sowing shaft revolutions can be monitored, on condition that the seed drill unit is fitted with the corresponding activated monitoring device. (See sections 5.1.4 and 5.1.5 for information on activating hopper level and sowing shaft monitoring.)

The monitoring systems are only active when the seed drill unit is in operating position (with lowered seed drill unit and/or marker arms).

The monitoring systems are not active when the seed drill unit is in transport position (with raised seed drill unit and/or marker arms).

### 7.1) Sowing shaft alarm

The sowing shaft monitoring system controls the turning of the sowing shaft. (Please refer to sect. 5.1.4 for information on how to activate sowing shaft monitoring).

A sensor receives impulses from a transmitting device on the sowing shaft. If 10 seconds pass without an impulse being received (with the unit in operating mode), visual and acoustic alarm signals are activated.

Acoustic alarm = intermittent sound

Visual alarm = <Err1>

The alarm can be stopped by pressing one of the green display keys, but will nevertheless be reactivated if the marker arms are operated or the machine is raised.

In the event of a fault occurring that cannot be dealt with immediately (e.g. a faulty sensor), it is possible to disable the monitoring system completely as a temporary measure, until the fault can be rectified. (Please refer to sect. 5.1.4 for details on how to disable sowing shaft monitoring).

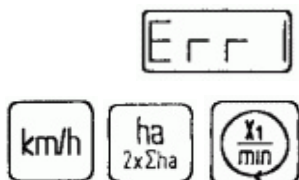

### 7.2) Hopper level alarm

The hopper level monitoring system controls the amount of seed in the hopper. (Refer to sect. 5.1.5 for details of how to activate hopper level monitoring).

The level display receives a sensor signal when the quantity drops to a certain level, activating an acoustic and visual alarm signal.

Acoustic alarm = intermittent sound

Visual alarm = <Err2>

The alarm can be stopped by pressing one of the green display keys, but will nevertheless be reactivated if the marker arms are operated or the machine is raised.

In the event of a fault occurring that cannot be dealt with immediately (e.g. a faulty sensor), it is possible to disable the monitoring system completely as a temporary measure, until the fault can be rectified. (Please refer to sect. 5.1.5 for details on how to disable hopper level monitoring).

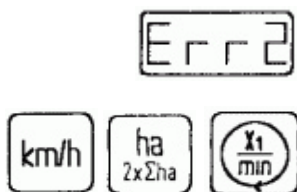

## 8) Configuring for machine type and local language

The Multitronic II seed drill monitor can be operated with both the MULTIDRILL range of mechanical seed drill machines and the TURBODRILL range of air-operated units.

The menus can be configured to appear in English, German or French.

The seed drill monitor is supplied factory-adjusted for the corresponding machine, but the user can change these parameters at any time:

Remove the power supply plug from its socket

With the **F** key pressed, push the plug back into the socket.

The display will show <tYPE> for the corresponding type of machine

Release the **F** key once more

Press the **F** key again to activate machine type configuration.

Use arrow keys **A** or **V** to select machine type **MULTIDRILL ME/MEL** (display <E-EL>)

and press the **F** key to save. (See sect. 5.1.7)

The display will show <tYPE> once more

Use arrow keys **A** or **V** to activate local language configuration (and to display <nAt>)

Press the **F** key to activate the language selection feature.

Use arrow keys **A** or **V** to select the desired language

English	Anzeige <EnGL>
French	Anzeige <FrAn>
German	Anzeige <EnGL>

Press the **F** key to save the selected language. (See sect. 5.1.7).

The display will show <nAt>once more

Configuration is now complete. Press any one of the green display pushbuttons to leave the menu.

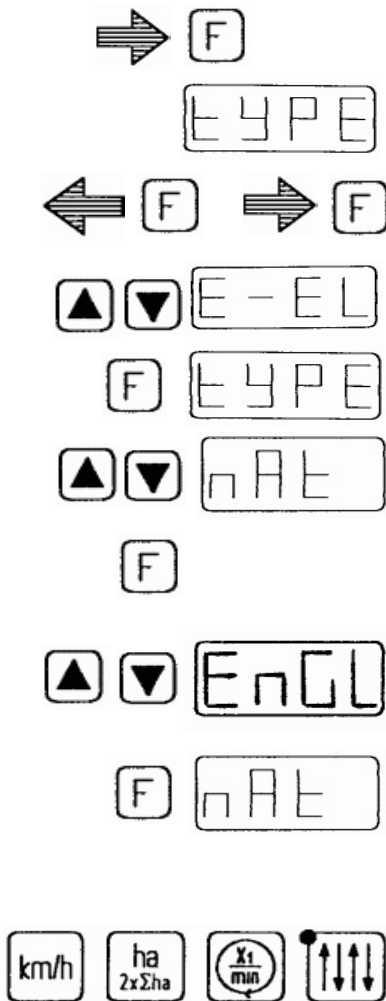

# CALIBRATION CHARTS

## MULTIDRILL

For further informations please refer to the operating instructions !

Because of the differences in specific weight, size and shape of seed, also the kind of dressing and method of treatments the figures stated in the charts can only be used as a guide.

**The exact amount drilled can only be ascertained by physical calibration tests.**

(1) It is essential to do first apprx 10 turns clockwise with the calibration crank to ensure that all seed housings are completely filled with seed. Make sure that the drill is level in horizontal and vertical plane.

Repeat the calibration test after apprx. 500 m distance in the field.

(2) Using the reversed rotation of the seed wheels ( Upper Discharge System) for fine seed in the range of up to 3,5 mm thickness ( all cereals must be drilled in the standard Normal Rotation (Bottom discharge System) the correct bottom flap position is always `0`.

The position `1` is only used when in Normal Rotation with larger sizes of seed the danger of grinding or cracking may occur which is audible.

(3) When drilling oil seed rape in Reversed Rotation the position of the slide gates depends on the flowing properties of the rape seed.

Judgement of the flowing properties and the position of the slide gates is descibed in the manual under „Seed Test“ and also on page 2 of the calibration chart.

(4) Drilling rape in the Normal Rotation the reduction fingers (white) must be fitted. and Bottom Flap position used in `0`.

(5) If for low seed rates Normal Rotation is used and the gearbox position is less than 10, it is necessary to use the option of halve the seed wheel revolutions to double the gearbox position.

A new calibration test is required afterwards !

# Slide gates position

## 1. For Reversed Rotation (upper discharge system)

9998.02.30      04/1999

Oberaussaat / Upper discharge system / Semis monograine

Federraste muß in mittlere Kerbe der Abdeckung einrasten !  
 Tension plate in central slot position !  
 Verrou dans encoche mediane du carter !

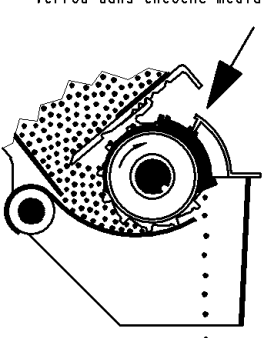
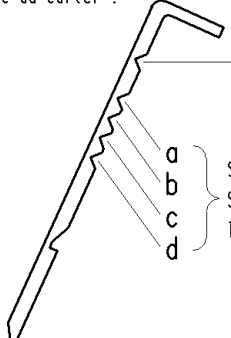



Schieber geschlossen  
Shutter closed  
Trappe fermee

a } Schieber geöffnet  
b } Shutter open  
c } Trappe ouverte  
d }

- Richtige Schieberstellung mit "Kornprobe" nach Betriebsanleitung ermitteln  
 - Korrekt shutter position acc. to "grain test" ref. manual  
 - Controler la position prescrite dans la notice par un essais

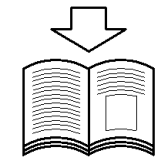
↓



## 2. For Normal Rotation (lower discharge system)

9998.02.31      04/1999

Unteraussaat / Lower discharge system / Semis classique

ohne Reduziereinsatz Without fine seed finger sans carter de reduction	gleiche Schieberstellung Same shutter position Meme position de trappe	mit Reduziereinsatz With fine seed finger Avec carter de reduction
--	--	--

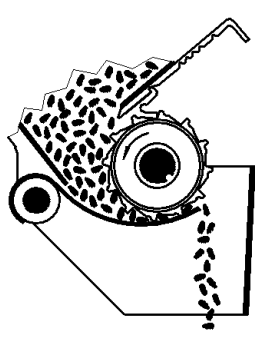
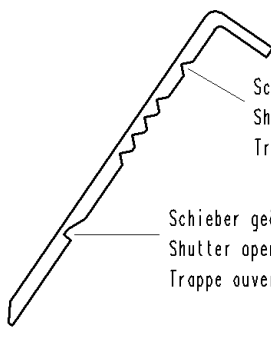
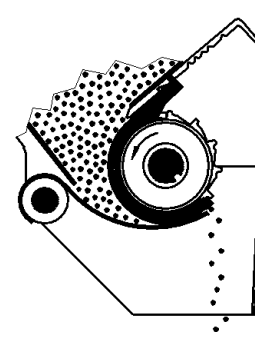
Schieber geschlossen  
Shutter closed  
Trappe fermee

Schieber geöffnet  
Shutter open  
Trappe ouverte

## CALIBRATION CHART MULTIDRILL

Seeds	Barley							Wheat, Rye, Triticale							
Bottom Flap Position	0*							0*							
Slide Gate Position	Fully Open							Fully Open							
Sowing System	Lower Discharge							Lower Discharge							
Optional Equipment	-----							-----							
Row Spacing (cm)	10	12	13	14	15	16	17	10	12	13	14	15	16	17	
Metering	20														
	25	94						109	91	84					
	30	112	93					132	110	101	94	88			
	35	131	109	100	93			154	128	118	110	102	96	90	
	40	149	124	114	106	99	93		175	146	135	125	117	109	103
Lever	45	168	140	129	120	112	105	99	197	164	151	140	131	123	115
	50	190	158	146	135	126	118	111	220	183	169	157	146	137	129
	55	205	171	158	146	137	128	121	241	201	185	172	161	151	142
Position	60	224	187	171	160	150	140	132	262	219	202	188	175	164	154
	65		202	186	173	162	151	142		237	218	203	190	178	167
	70			200	186	174	162	153			234	218	204	192	180
	75				200	186	174	164				234	219	205	193
	80					199	185	175					233	219	206
	85					197	185							232	218
	90						197								231

The figures stated are in kg/ha and can only be used as a guide.  
The exact amount drilled can only be ascertained by physical calibration tests.

\* For any seed in the range of up to 3,5 mm thickness (all grain types) the correct bottom flap position is always ' 0 '. The ' 1 ' position is only recommended for bigger sizes of seed when the danger of grinding or cracking may occur.

## CALIBRATION CHART MULTIDRILL

Seeds	Oats							Hybrid Rye							
Bottom Flap Position	0*							0*							
Slide Gate Position	Fully Open							Fully Open							
Sowing System	Lower Discharge							Reduced Lower Discharge							
Optional Equipment	-----							-----							
Row Spacing (cm)	10	12	13	14	15	16	17	10	12	13	14	15	16	17	
Metering	20							59	49						
	25							73	61	56					
	30	80						89	74	68	52				
	35	94	78					103	86	79	63	59	55	52	
	40	107	89	82					118	98	90	74	69	64	61
Lever	45	120	100	92	86			134	112	103	84	78	73	69	
	50	133	111	102	95	89	83	148	123	113	96	90	84	79	
Position	55	146	122	117	104	98	91	86				105	98	92	87
	60	161	134	124	115	107	100	94							
	65	174	145	134	124	116	109	102							
	70	187	156	144	134	125	117	110							
	75		167	154	143	134	125	118							
	80			164	152	143	133	125							
	85				162	152	142	133							
90						150	142								

The figures stated are in kg/ha and can only be used as a guide.  
The exact amount drilled can only be ascertained by physical calibration tests.

\* For any seed in the range of up to 3,5 mm thickness (all grain types) the correct bottom flap position is always '0'. The '1' position is only recommended for bigger sizes of seed when the danger of grinding or cracking may occur.

## CALIBRATION CHART MULTIDRILL

Seeds	Grass Seed							Phacelia							
Bottom Flap Position	0							0							
Slide Gate Position	Fully Open							Fully Open							
Sowing System	Lower Discharge							Lower Discharge							
Optional Equipment	-----							Special Reducing Cover							
Row Spacing (cm)	10	12	13	14	15	16	17	10	12	13	14	15	16	17	
Metering	5	12	10	9,2	8,5	8	7,5	7	3,7	3,1	2,8	5,3	5,0	4,6	4,3
	10	24	20	18	17	16	15	14	7,4	6,2	5,7	7,9	7,4	6,9	6,4
	15	36	30	28	26	24	22	21	11	9,2	8,4	10,5	9,8	9,2	8,7
	20	48	40	37	34	32	30	28	14,8	12,3	11,3	13,2	13,2	11,5	10,8
	25	60	50	46	43	40	37	35	18,5	15,4	14,2	15,8	14,8	13,8	13,0
	30	72	60	55	51	48	45	42	22,2	18,5	17,0	18,5	17,3	16,2	15,2
Lever	35	85	71	66	61	57	53	50		21,6	19,9	21,2	19,8	18,5	17,4
	40	97	81	75	69	65	60	57			22,8		22,2	20,8	19,6
Position	45													23,1	21,7
	50														
	55														
	60														
	65														
	70														
75															

The figures stated are in kg/ha and can only be used as a guide.  
The exact amount drilled can only be ascertained by physical calibration tests.

\* For any seed in the range of up to 3,5 mm thickness (all grain types) the correct bottom flap position is always '0'. The '1' position is only recommended for bigger sizes of seed when the danger of grinding or cracking may occur.

## CALIBRATION CHART MULTIDRILL

Seeds	Oil Seed Rape							Mustard							
Bottom Flap Position	0							0							
Slide Gate Position	Fully Open							Fully Open							
Sowing System	Lower Discharge							Lower Discharge							
Optional Equipment	Special Reducing Cover							Special Reducing Cover							
Row Spacing (cm)	10	12	13	14	15	16	17	10	12	13	14	15	16	17	
<b>Metering</b>	5	3,6	3,0	2,8				5,4							
	10	7,2	6,0	5,5	5,1	4,8	4,5	4,2	10,8	9,0	8,3	7,7	10,8	10,1	9,5
	15	10,8	9,0	8,4	7,6	7,2	6,7	6,3	16,2	13,5	12,5	11,6	14,4	13,5	12,7
	20									18,0	16,6	15,4	18,0	16,8	15,9
	25									22,5	20,8	19,3	21,6	20,2	19,0
<b>Lever</b>	30														
	35														
	40														
<b>Position</b>	45														
	50														
	55														
	60														
	65														
70															
75															

The figures stated are in kg/ha and can only be used as a guide.  
The exact amount drilled can only be ascertained by physical calibration tests.

\* For any seed in the range of up to 3,5 mm thickness (all grain types) the correct bottom flap position is always ' 0 '. The ' 1 ' position is only recommended for bigger sizes of seed when the danger of grinding or cracking may occur.



## CALIBRATION CHART MULTIDRILL

Seeds	Peas													
Bottom Flap Position	4 or 5*													
Slide Gate Position	Fully Open													
Sowing System	Lower Discharge													
Optional Equipment	-----													
Row Spacing (cm)	10	12	13	14	15	16	17	10	12	13	14	15	16	17
Metering  Lever  Position	5													
	10	122	102											
	15	184	153	141	131	122	115	145						
	20	245	204	188	175	163	153	180						
	25	306	255	235	220	205	191	216						
	30	367	306	282	262	245	230	252						
	35	428	357	330	305	286	268	288						
	40	490	408	376	350	326	305	325						
	45	550	460	424	393	367	345	360						
	50	612	510	470	437	408	382							
55														
60														
65														
70														
75														

The figures stated are in kg/ha and can only be used as a guide.  
The exact amount drilled can only be ascertained by physical calibration tests.

\* For any seed in the range of up to 3,5 mm thickness (all grain types) the correct bottom flap position is always '0'. The '1' position is only recommended for bigger sizes of seed when the danger of grinding or cracking may occur.

## DRILLING OF OIL SEED RAPE IN UPPER DISCHARGE SYSTEM

- Slide Gate Position:
- 1a For well flowing seed (incrusted, natural)
  - 1b For normal flowing seed (powder dressed, talced)
  - 1c For poor flowing seed ( TGW - Thousand grain weight over 6 g )
  - 1d For very well flowing seed and when vibrations are being transferred from cloddy or stoney soil or from the rotary harrow.

Bottom Flap Position: 0

Metering Lever Position	Theoretical Seed Spacing cm	Max. Working Speed km/h	Seed Rate							
			TGW = 5g		TGW = 4g		TGW = 4g			
			Row Spacing 10 cm kg/ha	Row Spacing 12 cm Grains/sqm	Row Spacing 10 cm kg/ha	Row Spacing 12 cm Grains/sqm	Row Spacing 10 cm kg/ha	Row Spacing 12 cm Grains/sqm		
100	7,1	4,4	6,7	135	5,6	112	5,4	135	4,45	111
90	7,85	4,9	6	121	5	100	4,8	121	4	100
80	8,8	5,5	5,4	108	4,5	90	4,3	108	3,6	91
70	10	6,2	4,7	94	3,95	79	3,75	94	3,2	79
60	11,8	7,3*	4,1	83	3,3	69	3,3	83	2,85	69
50	14,1	8,7*	3,4	67	2,8	56	2,7	67	2,25	56
40	17,8	8,7*	2,7	54	2,25	45	2,15	54	1,8	45
30	23,5	8,7*	2	41	1,7	34	1,65	41	1,4	35
20	35,5	8,7*	1,35	27	1,1	21,5	1,1	28	0,9	22

Reduce working speed to 3,5 km/h on slopes which are tilting more than 15%.  
The recommended speed under normal conditions is 6 km/h.



# **For Your Own Safety**

**In this enclosure to the operating instructions you will find some general rules of conduct explaining how to operate the implement correctly - and some safety advice which we advise you to observe for your own safety!**

**The list is very extensive, and some of the advice does not specifically relate to the implement supplied. However, the summary of advice is to remind you of safety guidelines which are often unconsciously ignored when operating the machines and implements on a daily basis.**

## **1. Authorized Use**

The implement has been specifically built to perform standard operations pertaining to agricultural work (authorized use).

Any type of usage outside of these parameters is deemed to be improper usage. The manufacturer accepts no responsibility for damage resulting from such usage, and the risks are to be borne solely by the user.

Within the bounds of authorized usage it is also necessary to adhere to the manufacturer's prescribed operational, maintenance and service conditions.

The implement may only be used, maintained or serviced by people who are familiar with such an implement and aware of the risks involved. Please also ensure that all safety instructions are passed on to other users.

It is important that any and all relevant accident prevention regulations and any other generally recognized safety, industrial hygiene and road traffic regulations be observed.

Modifications to the implement made by the user will void any liability on the part of the manufacturer for any resulting damage.

## **2. General Safety Advice and Accident Prevention Regulations**

- Before starting up your implement and tractor, please check that it is roadworthy and operatively safe.
- Please observe all generally valid safety and accident prevention regulations.
- The warnings and signs found on the implement are there to provide essential data needed to operate the unit safely. Please observe these for your own safety.
- When using public roads always follow the relevant traffic regulations.
- Before commencing work, ensure that you are familiar with all devices and operating controls as well as with the functions these perform. It is too late to do so once the implement is in operation!
- Operators should wear tight-fitting clothing. Try to avoid wearing loose clothing wherever possible!
- The machine should be kept clean to prevent the risk of fire!
- Check the immediate surroundings before driving off and putting the machine into operation! (Beware of children!) Ensure that you have sufficient visibility!
- Riding on the equipment during work or transportation is not allowed!
- Implements should be correctly coupled and only secured to the specified appliances.
- Special care is to be taken when coupling and uncoupling implements to or from the tractor.
- When coupling and uncoupling supports, always position them correctly. (Stability)
- Always ensure that weights are only added correctly to the specified mounting points.
- Observe all permissible axle loads, total weights and transportation dimensions.
- Check and mount transportation equipment such as lighting, warning devices, and guards, if necessary.
- Ensure that the release ropes used for rapid coupling and uncoupling hang loose and do not automatically release when in a low position.
- Never leave the operating platform when in transit.

- Road, steering and braking performance will be influenced by mounted or attached implements and ballast. Therefore make sure that you have sufficient steering and brake capability.
- Account for the width of the implement and its working load when taking corners.
- Only operate implements once all the safety devices/guards have been mounted and are in protection mode.
- Keep clear of working areas at all times.
- Keep clear of rotating and swinging parts on the implement.
- Ensure the swinging parts are clear of bystanders before operating any hydraulic folding frames.
- Power-steered parts (e.g. hydraulics) can cause crushing or amputation!
- On high-speed implements with ground-driven implements beware of after-running swinging parts! Only approach once the implement is at a complete standstill!
- Before leaving the tractor, lower the implement to the ground, switch off the engine and remove the ignition key!
- Do not allow anyone to stand between the tractor and the implement without first having secured the vehicle against running away by putting on the handbrake and/or using wheel chocks.
- Ensure that the folded-in frames and lifting equipment are securely in transportation position.
- Fold in and lock the packer catching arms before transporting on roads.
- Lock the marker arms to transportation position.

## **2.1 Coupled Implements**

- Before coupling or uncoupling an implement to the three-point linkage, position the operating device in such a way as to prevent unintentional lifting or lowering.
- When using the three-point linkage it is vital that the coupling configurations of the tractor and implement correspond or are co-ordinated.
- There is a risk of injury through crushing or amputation near the three-point linkage.

- When using the external controls to operate the three-point linkage, keep clear of the area between the tractor and the implement.
- When the implement is in transportation position, always ensure that the tractor's three-point linkage is sufficiently locked at the side.
- When transporting a raised implement on public roads ensure the control lever is locked in place to prevent accidental lowering.

## **2.2 Mounted Implements**

- Secure the implement to prevent it from running away.
- Observe the max. permissible bearing loads for the trailer coupling, swinging drawbar or hitch.
- If a drawbar trailer is used, ensure that there is sufficient manoeuvrability at the towing point.

## **2.3 PTO Drive (applies only to PTO-driven implements)**

- Only use the drive shafts specified by the manufacturer.
- A pipe shield and protective bell must be mounted on the drive shaft as well as a PTO guard – also possible on the implement - and must be in perfect working order.
- Ensure the specified pipe covers are used on the drive shafts when in transportation and working position.
- Only couple and uncouple the drive shaft once the PTO has been disengaged, the engine switched off and the ignition key removed.
- Ensure that the drive shaft is mounted and secured correctly at all times.
- Secure the drive shaft guard by locking the chains in place to prevent them from turning.
- Before engaging the PTO make sure that the PTO speed chosen on the tractor complies with the permissible speed of the implement.
- When using ground speed power take-off ensure that the speed is regulated by the travel speed and that the direction of rotation changes when reversing.

- Before engaging the PTO make sure that the area of danger around the implement is free of bystanders.
- Never engage the PTO when the engine is switched off.
- When working with the PTO, keep the area around the rotating PTO and drive shaft clear of any bystanders.
- Always disengage the PTO where the bends are too big and it is not needed.
- Caution! Beware of after-running gyrating loads after disengaging the PTO! Do not stand too close to the implement during this time. Only begin working on it once it has come to a complete standstill. It is essential that you switch off the engine and remove the ignition key.
- Before cleaning, greasing or adjusting a PTO-driven implement or its drive shaft, always disengage the PTO, switch off the engine and remove the ignition key.
- Place the uncoupled drive shaft on the specified support.
- Cover the stump of the PTO with a protective cover after dismounting the drive shaft.
- Any damage which may arise should be repaired immediately. Never work with a damaged implement.

## 2.4 Hydraulic Equipment

- Hydraulic equipment is under very high pressure.
- When connecting hydraulic cylinders and motors ensure that the hydraulic hoses are connected as specified.
- When connecting hydraulic hoses to the tractor's hydraulics ensure that the hydraulics are depressurized on the tractor and the implement.
- Where it is necessary to connect hydraulic functions between the tractor and the implement, the coupling sockets and plugs should be marked to prevent faulty operation. Mixing up the connections will reverse the functions (e.g. lift/lower) - **Risk of injury!**
- Check the hydraulic hose connections at regular intervals and replace if damaged or aged. The replacement hydraulic hoses must comply with the technical requirements stipulated by the implement manufacturer.
- When looking for leaks, use suitable aids and resources to prevent injury.

- Liquids that leak at high pressure (hydraulic oil) can penetrate the skin and cause serious injury! In the event of injury, consult a doctor immediately. Risk of infection!
- Before working on hydraulic units, lower the implement, depressurize the system, switch off the engine and remove the ignition key.

## **2.5 Brakes and Tyres**

- Check that the brakes are functional before every journey.
- Thorough checks are to be performed on the brake systems at regular intervals.
- Adjustments or repairs to the brake system may only be performed by qualified staff or recognized brake service centres. Only use the prescribed brake fluid and replace as specified.
- When working on the tyres please ensure that the implement has been securely parked and cannot run away (wheel chocks).
- Fitting tyres requires having sufficient training and the correct fitting tools.
- Wheel and tyre repairs may only be performed by qualified staff using the correct fitting tools.
- Check the air pressure at regular intervals observing the prescribed air pressures given.

## **2.6 Maintenance**

- Service, maintenance and cleaning work as well as the elimination of malfunctions should only be carried out once the drive unit has been switched off and the engine has come to a standstill. Remove the ignition key.
- Check that the nuts and bolts are snug, and tighten as necessary.
- When carrying out maintenance work on a raised implement always secure using suitable support elements.
- When replacing bladed working tools use the appropriate tools and gloves.
- Dispose of all oils, grease and filters in a due and proper manner.
- Always disconnect the power supply before working on electrical equipment.



- When performing electrical welding work on a tractor with a mounted implement disconnect any cables connected to the generator and the battery.
- Gas tanks must only be filled using nitrogen to avoid risk of explosion.!
- Spare parts must at a minimum comply with the technical requirements given by the manufacturer of the implement. We therefore recommend that for your own safety you **use original parts only!**

### **2.7 Additional Hints and Tips: Mechanical Seed Drills**

- Danger! Beware of rotating and oscillating machine parts when performing a calibration test.
- Only use the tread plates for filling purposes. Riding on the machine during operation is prohibited.
- When transporting on public roads protect or remove the thrust collars on the pre-emergence marking.
- When filling the seed hopper, observe the information provided by the implement manufacturer.
- Lock row markers in transportation position.
- Do not place any foreign parts in the seed hopper – the agitating shaft also rotates during manoeuvring.
- Observe the permissible filling quantities.



# Explanation of the Pictogram Symbols



3.00

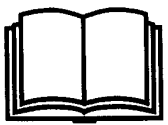

Warning symbols warn of possible danger areas. They are pointing out safe operation of the unit.



Keep the warning symbols clearly visible and clean and replace when damaged or re-sprayed by paint. They can be ordered under the order numbers stated.

1 9998.02.59	  9998.002.59	Read operators instruction book before operation and ensure you understand the safety advices and the informations contains in it.
-----------------	--	--

2 9998.02.73	  9998.02.73	Retighten all screws and bolts after the initial hours of work, and check regularly for tightness thereafter. For torque settings refer to manual or parts list. Use torque limiting spanner.
-----------------	---	---

3 9998.02.56	  9998.02.56	Never allow people to stand or sit on the machine during work or in transport. Enter filling platform only when the machine is not in motion.
-----------------	---	--

4 9998.02.53	  9998.02.53	Folding wings. Keep away! Keep clear and do not enter danger area. When extending take care of sufficient space.
-----------------	---	--

5 9998.02.52	  9998.02.52	Plough may turn or swing in. Keep away. Do not enter danger area.
-----------------	---	--

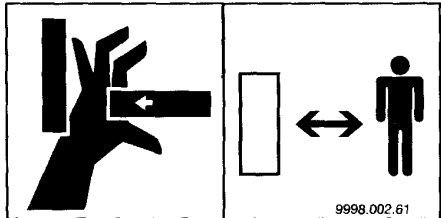
<p>6</p> <p>9998.02.61</p>	 <p>9998.002.61</p>	<p>Danger of squeezing. Keep away!</p>
----------------------------	--	--

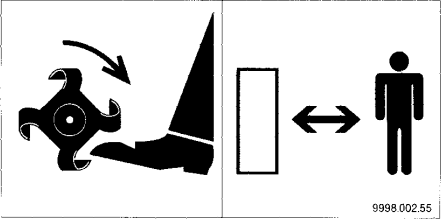
<p>7</p> <p>9998.02.55</p>	 <p>9998.002.55</p>	<p>Rotating tools. Keep away! Do not grasp behind safety devices or covers. Never carry out work unless PTO-drive is disengaged and the engine is stopped.</p>
----------------------------	--	--

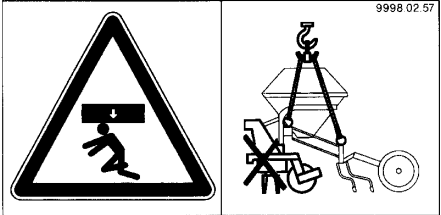
<p>8</p> <p>9998.02.57</p>	 <p>9998.02.57</p>	<p><b>Danger of Life</b> by load from top! Lift Turbodrill only with empty hopper and never together with rotary harrow. Use safe lifting gear and fit straps only on hooks provided.</p>
----------------------------	--	---

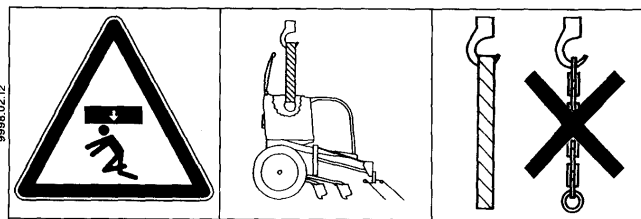
<p>9</p> <p>9998.02.12</p>	 <p>9998.02.12</p> <p>11/1995</p>	<p><b>Danger of Life</b> by load from top! For lifting seed drills use only straps. No chains. Fit straps on divider plate inside the hopper.</p>
----------------------------	--	---

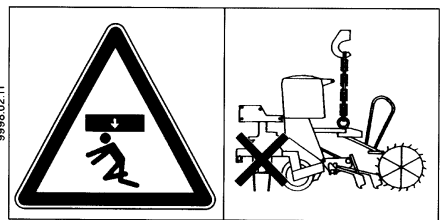
<p>10</p> <p>9998.02.11</p>	 <p>9998.02.11</p> <p>11/1995</p>	<p><b>Danger of Life</b> by load from top! Lift with empty hopper only and never with rotary harrow or any other implement attached. Use safe lifting gear and fit straps only on hooks provided.</p>
-----------------------------	--	---

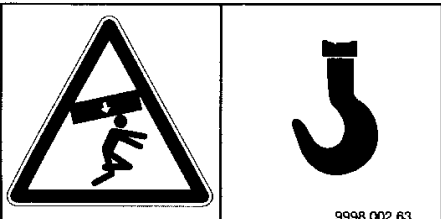
<p>11</p> <p>9998.02.63</p>	 <p>9998.002.63</p>	<p>Use suitable and safe lifting gear and fasten here. Keep a safe distance from the machine being lifted.</p>
-----------------------------	--	--

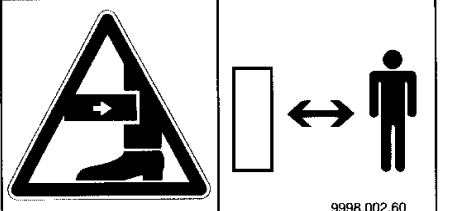
<p><b>12</b></p> <p>9998.02.60</p>	 <p>9998.002.60</p>	<p>Danger of leg injuries when elements may suddenly swing out. Keep away!</p>
------------------------------------	--	--

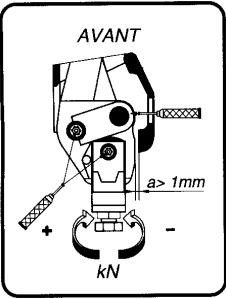
<p><b>13</b></p> <p>9998.02.58</p>		<p>Grease all marked grease nipples regularly. The reset force can be increased by adjusting the bolt (kN) to the left (!). Reduce by turning to the right. There must be always a <b>minimum</b> clearance <b>a</b> of <b>1 mm</b>. Caution! Spring is pre-loaded. Do not dismantle or remove spring system without the use of special tools and without being familiar with the dismantling instructions provided by the manufacturer. <b>Danger of Life!</b></p>
------------------------------------	---	---

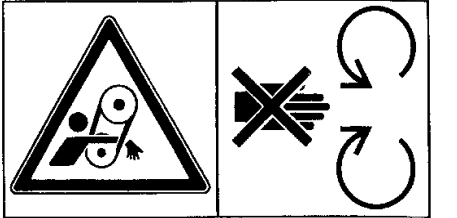
<p><b>14</b></p> <p>9998.02.64</p>	 <p>9998.02.64</p>	<p>Never open or remove any safety guards when the unit is running. Keep away!</p>
------------------------------------	--	--

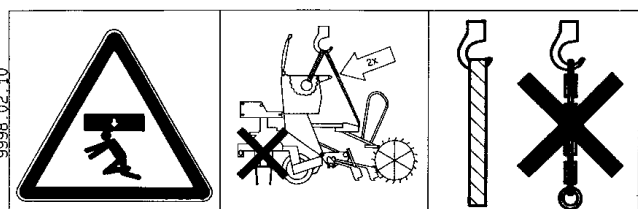
<p><b>15</b></p> <p>9998.02.10</p>	 <p>9998.02.10</p> <p>8661/20</p>	<p><b>Danger of Life</b> by load from top! Lift with empty hopper only and never with rotary harrow or any other implement attached. Fit straps on divider plate inside the hopper and only on hooks provided. Use <b>no</b> chains.</p>
------------------------------------	--	--